

FAX Operation Guide

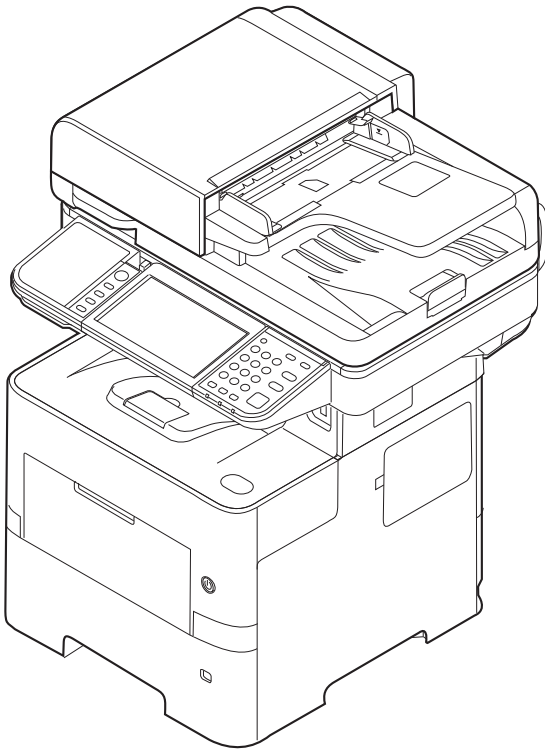

Contents

Contents	i
Preface	v
About the FAX Operation Guide (this Guide)	v
Structure of the guide	v
Conventions Used in This Guide	vi

1 Legal and Safety Information 1-1

Notice	1-2
Safety Conventions in This Guide	1-2
About this Operation Guide	1-3
Legal Notice	1-3
IMPORTANT SAFETY INSTRUCTIONS	1-3
IMPORTANTES MESURES DE SECURITE	1-4
Technical regulations for terminal equipment	1-5
Network Compatibility Declaration	1-5
Trademark Information	1-6

2 Before Using the Fax Machine 2-1

Part Names and Functions	2-2
Machine	2-2
Operation Panel	2-4
Touch Panel	2-5
Enter key and Quick No. Search key	2-6
Quick Setup Wizard (Fax Setup)	2-7
Fax setup items	2-7
Fax setup procedure	2-8
Setting Date and Time	2-9
PBX Setting (Europe only)	2-10
Registering Destinations in the Address Book	2-11
Adding a Destination (Address Book)	2-11
Adding a Destination on One Touch Key	2-17

3 Sending Faxes 3-1

Basic transmission procedure	3-2
Checking the Send Status	3-4
Priority Override Send	3-4
Cancelling the Transmission	3-5
Using redial	3-6
Methods For Entering the Destination	3-7
Entering the destination fax number with the numeric keys	3-7
Choosing from the Address Book	3-9
Choosing by One Touch Key	3-10
Using the Speed Dial key	3-10
Broadcast Transmission	3-11
Login/Logout	3-13
Logging in when User Accounting has been Enabled	3-13
Logging in when Job Accounting has been Enabled	3-14
Fax transmission functions	3-15
Quiet Mode	3-16
Original Size	3-16
Original Orientation	3-16
Duplex	3-16
FAX TX Resolution	3-17
Density	3-17
Original Image	3-17

Continuous Scan	3-18
FAX Direct Transmission	3-18
Cancelling Direct Transmission	3-18
Manual Send	3-19
FAX Delayed Transmission	3-20
Cancelling and Sending Delayed Transmissions (Queued)	3-21
Standby Transmission	3-21
Interrupt Send	3-22
Job Finish Notice	3-23
File Name Entry	3-23
Long Original	3-23
FAX TX Report	3-23
Using chain dial	3-24
Using favorites	3-26

4 Receiving Faxes 4-1

FAX Automatic Reception	4-2
Reception Method	4-2
Checking and Changing the Reception Method	4-2
Flow of reception	4-3
Canceling reception (Disconnection of communication)	4-3
Manual Reception	4-4
Flow of reception	4-4
Fax reception functions	4-5
Fax reception settings	4-6
Duplex Printing	4-6
2 in 1 Print	4-6
Batch Print	4-6
Reception Date/Time	4-6
Media Type for Print Output	4-7

5 Using Convenient Fax Functions 5-1

Forward Settings	5-2
Type of Forwarding Destination	5-2
Setting Forwarding	5-2
Registering Forwarding Destination	5-2
Changing and Deleting Registration Contents	5-3
Forwarding Time Setting	5-4
File Format Setting	5-4
File Separation	5-4
E-mail Subject Add. Info. Setting	5-5
FTP Encrypted TX Setting	5-5
Print Setting	5-5
File Name Registration	5-6
Settings for Forwarding from Embedded Web Server RX (Forward Settings)	5-7
Sub Address Box Function	5-8
Sub Address Box	5-8
Sub Address Communication	5-8
Registering a Sub Address Box	5-9
Changing/Deleting Sub Address Box	5-10
Printing Originals from a Sub Address Box	5-11
Checking Details	5-12
Deleting Originals after Printing from a Sub Address Box	5-12
Deleting Originals from a Sub Address Box	5-13
Printing a Sub Address Box List	5-13
Sub Address Transmission	5-14
Polling Communication	5-15
Polling Transmission	5-15

Polling Reception	5-17
Printing from a Polling Box	5-19
Checking Details	5-20
Deleting Originals in a Polling Box	5-20
FAX Memory RX Box	5-21
How to print from the FAX Memory RX Box	5-21
How to delete a fax from the FAX Memory RX Box	5-22
Encryption	5-23
Registering an Encryption Key	5-24
Changing and Deleting Registration Contents of Encryption Key	5-25
Using the Encrypted Transmission	5-26
Setting the Encrypted Reception	5-27
Using a Connected Telephone	5-28
FAX/TEL Auto Switch Reception	5-28
FAX/Answering Machine Auto Switch Reception	5-30
DRD Reception (Available for some countries.)	5-32
Manual Send	5-34
Manual Reception	5-35
Remote Switch Function	5-36

6 Sending Faxes from PC 6-1

Flow of Network FAX Sending	6-2
Flow of Network FAX Receiving	6-2
Setup	6-3
Installing the FAX Driver	6-3
Uninstalling the FAX Driver	6-6
Basic Transmission	6-7
Configuring the Driver Default Settings	6-10
Default Settings Dialog Box	6-11
Changing Transmit Settings	6-14
Using Cover Pages	6-19
Cover Page Registration (Default Settings)	6-24
Transmission Control	6-29

7 Managing Jobs 7-1

Various Tools for Checking Transmission Results and Registration Status	7-2
Checking FAX Job History	7-3
Displaying Job Log Screen	7-3
Printing Administrative Reports (Result Report Setting)	7-4
Send Result Reports	7-4
Attached image when a network fax is sent	7-4
Report for Job Canceled before Sending	7-5
Recipient Format	7-5
FAX RX Result Reports	7-6
Activity Report (Outgoing FAX Report and Incoming FAX Report)	7-7
Printing Activity Reports	7-7
Automatic Printout	7-7
Status Page	7-8
Reporting FAX Receipt Result by E-mail	7-9
Confirmation Screen of Destinations	7-10

8 Fax Settings 8-1

Default fax settings	8-2
Operation method	8-2
System Menu Settings	8-3
Report	8-4
Cassette/MP Tray Settings	8-5

Common Settings	8-5
Document Box	8-6
FAX	8-7
Transmission Restriction	8-11
Registering Permit FAX No.	8-12
Changing and Deleting Permit FAX No.	8-13
Registering Reject FAX No.	8-14
Changing and Deleting Reject FAX No.	8-15
Registering Permit ID No.	8-16
Changing and Deleting Permit ID No.	8-17
Setting Send Restriction	8-18
Setting Reception Restriction	8-18
Unknown Number Reception	8-18
Unusable Time	8-19
Account Management	8-20

9 Troubleshooting 9-1

Indicators During Sending/Receiving Operation	9-2
Responding to an Attention Indicator Flashes	9-2
Precautions When Turning Power OFF	9-3
Messages	9-4
Error Code List	9-5
Troubleshooting	9-8
Common inquiries	9-10

10 Appendix 10-1

Character Entry Method	10-2
Entry Screens	10-2
Entering Characters	10-4
Specifications	10-5
Menu Map	10-7
Received FAX Sizes and Paper Priority (Metric Model)	10-13
Received FAX Sizes and Paper Priority (Inch Model)	10-14
Index	Index-1

Preface

This Operation Guide is intended to help you operate the machine correctly, perform routine maintenance and take a simple troubleshooting action as necessary, so that you can always use the machine in good condition.

Please read the Operation Guide before using the facsimile. Keep it close to the facsimile for easy reference.

About the FAX Operation Guide (this Guide)

Structure of the guide

This Operation Guide contains the following chapters.

Chapter		Contents
1	Legal and Safety Information	Provides precautions regarding use of the machine and trademark information.
2	Before Using the Fax Machine	Explains the part names and the quick setup wizard.
3	Sending Faxes	Explains the general methods for sending faxes and transmission functions.
4	Receiving Faxes	Explains the general methods for receiving faxes and reception functions.
5	Using Convenient Fax Functions	Explains convenient fax functions such as storing received faxes in boxes in the memory, forwarding received faxes, and polling communication (a function that allows the receiving party to call and initiate fax reception).
6	Sending Faxes from PC	Explains how to send a FAX from a PC.
7	Managing Jobs	Explains how to check the status of recently performed transmission and reception operations in the touch panel. Also explains how to print administrative reports showing communication results, machine settings, and registered information.
8	Fax Settings	Explains various settings for controlling fax usage, such as restricting transmission destinations, blocking fax reception, and setting prohibited use times.
9	Troubleshooting	Explains what to do when errors are displayed or other problems occur.
10	Appendix	Explains how to enter characters, and lists the fax specifications.

Conventions Used in This Guide

Adobe Reader X is used as an example in the explanations below.

Click an item in the Table of Contents to jump to the corresponding page.

Click to move from the current page to the previously displayed page. This is convenient when you want to return to the page from which you jumped to the current page.

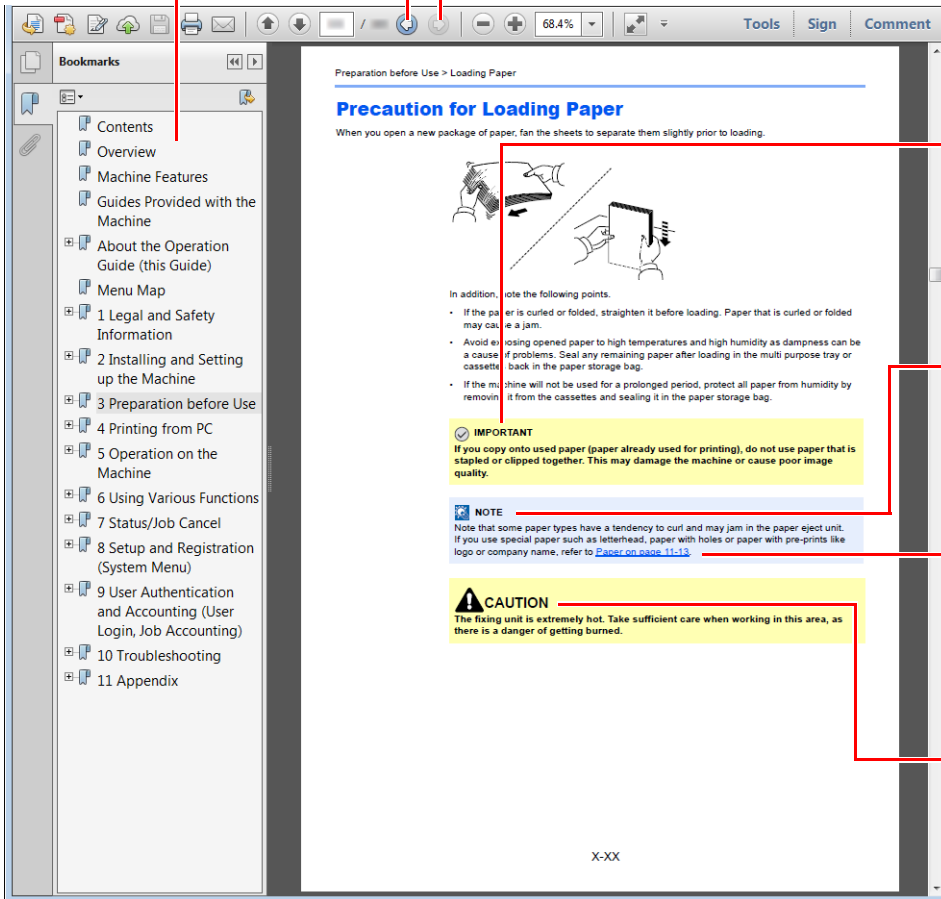

IMPORTANT
Indicates operational requirements and restrictions to operate the machine correctly, and avoid damage to the machine or property.

NOTE
Indicates supplemental explanations and reference information for operations.

Refer to
Click the underlined text to jump to the corresponding page.

Indicates that personal injury or mechanical damage may result from insufficient attention to or incorrect compliance with the related points.

NOTE

The items that appear in Adobe Reader vary depending on how it is used. If the Table of Contents or tools do not appear, refer to Adobe Reader Help.

Certain items are indicated in this guide by the conventions described below.

Convention	Description
[Bold]	Indicates keys and buttons.
"Regular"	Indicates a message or setting.

Conventions used in procedures for operating the machine

In this Operation Guide, continuous operation of the keys on the touch panel is as follows:

Actual procedure	Procedure indicated in this guide
Select the [S ystem Menu/Counter] key ▼ Select [▼] ▼ Select [C ommon Settings] ▼ Select [S ound]	[S ystem Menu/Counter] key > [C ommon Settings] > [S ound]

1 Legal and Safety Information



Please read this information before using your machine. This chapter provides information on the following topics.

Notice	1-2
Safety Conventions in This Guide	1-2
About this Operation Guide	1-3
Legal Notice	1-3
IMPORTANT SAFETY INSTRUCTIONS	1-3
IMPORTANTES MESURES DE SECURITE	1-4
Technical regulations for terminal equipment	1-5
Network Compatibility Declaration	1-5
Trademark Information	1-6

Notice



Safety Conventions in This Guide

The sections of this handbook and parts of the facsimile marked with symbols are safety warnings meant to protect the user, other individuals and surrounding objects, and ensure correct and safe usage of the facsimile.



-  **WARNING:** Indicates that serious injury or even death may result from insufficient attention to or incorrect compliance with the related points.
-  **CAUTION:** Indicates that personal injury or mechanical damage may result from insufficient attention to or incorrect compliance with the related points.

Symbols



The  symbol indicates that the related section includes safety warnings. Specific points of attention are indicated inside the symbol.

-  ... [General warning]
-  ... [Warning of high temperature]

The  symbol indicates that the related section includes information on prohibited actions. Specifics of the prohibited action are indicated inside the symbol.

-  ... [Warning of prohibited action]
-  ... [Disassembly prohibited]

The  symbol indicates that the related section includes information on actions which must be performed. Specifics of the required action are indicated inside the symbol.

-  ... [Alert of required action]
-  ... [Remove the power plug from the outlet]
-  ... [Always connect the machine to an outlet with a ground connection]

Please contact your service representative to order a replacement if the safety warnings in this Operation Guide are illegible or if the guide itself is missing (fee required).



NOTE

Due to performance updating, information in this Operation Guide is subject to change without notice.

About this Operation Guide

This Operation Guide contains information on using the facsimile functions of this machine. Please read the Operation Guide before you start using the machine.

During use, refer to the Operation Guide for your machine for information regarding the sections listed below.

Environment
Precautions for Use
Loading Paper
Toner Container Replacement
Waste Toner Box Replacement
Cleaning
Solving Malfunctions
Responding to Error Messages
Clearing Paper Jams

Legal Notice

WE SHALL HAVE NO LIABILITY FOR LOSS, WHETHER OR PARTIAL, OF RECEIVED DOCUMENTS WHEN SUCH LOSS IS CAUSED BY DAMAGES TO THE FAX SYSTEM, MALFUNCTIONS, MISUSE, OR EXTERNAL FACTORS SUCH AS POWER OUTAGES; OR FOR PURELY ECONOMIC LOSSES OR LOST PROFITS RESULTING FROM MISSED OPPORTUNITIES ATTRIBUTABLE TO MISSED CALLS OR RECORDED MESSAGES RESULTING THEREFROM.

IMPORTANT SAFETY INSTRUCTIONS

When using your telephone equipment, basic safety precautions should always be followed to reduce the risk of fire, electric shock and injury to persons, including the following:

CAUTION: To reduce the risk of fire, use only No.26 AWG or larger UL listed or CSA certified telecommunication line cord.

- 1 Do not use this product near water, for example, near a bath tub, wash bowl, kitchen sink or laundry tub, in a wet basement or near a swimming pool.
- 2 Avoid using a telephone (other than a cordless type) during an electrical storm. There may be a remote risk of electric shock from lightning.
- 3 Do not use the telephone to report a gas leak in the vicinity of the leak.
- 4 Use only the power cord and batteries indicated in this manual. Do not dispose of batteries in a fire. They may explode. Check with local codes for possible special disposal instructions.

SAVE THESE INSTRUCTIONS

IMPORTANTES MESURES DE SECURITE

Certaines mesures de sécurité doivent être prises pendant l'utilisation de matériel téléphonique afin de réduire les risques d'incendie, de choc électrique et de blessures. En voici quelques unes:

- 1 Ne pas utiliser l'appareil près de l'eau, p. ex., près d'une baignoire, d'un lavabo, d'un évier de cuisine, d'un bac à laver, dans un sous-sol humide ou près d'une piscine.
- 2 Eviter d'utiliser le téléphone (sauf s'il s'agit d'un appareil sans fil) pendant un orage électrique. Ceci peut présenter un risque de choc électrique causé par la foudre.
- 3 Ne pas utiliser l'appareil téléphonique pour signaler une fuite de gaz s'il est situé près de la fuite.
- 4 Utiliser seulement le cordon d'alimentation et le type de piles indiqués dans ce manuel. Ne pas jeter les piles dans le feu: elles peuvent exploser. Se conformer aux règlements pertinents quant à l'élimination des piles.

CONSERVER CES INSTRUCTIONS

Technical regulations for terminal equipment

Terminal Equipment (TE);TBR 21

Attachment requirements for pan-European approval for connection to the analogue Public Switched Telephone Networks (PSTNs) of TE (excluding TE supporting the voice telephony service) in which network addressing, if provided, is by means of Dual Tone Multi Frequency (DTMF) signalling.

This terminal equipment complies with:

- TBR21
- AN 01R00 AN for P
- AN 02R01 AN for CH and N
- AN 05R01 AN for D, E, GR, P and N
- AN 06R00 AN for D, GR and P
- AN 07R01 AN for D, E, P and N
- AN 09R00 AN for D
- AN 10R00 AN for D
- AN 11R00 AN for P
- AN 12R00 AN for E
- AN 16R00 General Advisory Note
- DE 03R00 National AN for D
- DE 04R00 National AN for D
- DE 05R00 National AN for D
- DE 08R00 National AN for D
- DE 09R00 National AN for D
- DE 12R00 National AN for D
- DE 14R00 National AN for D
- ES 01R01 National AN for E
- GR 01R00 National AN for GR
- GR 03R00 National AN for GR
- GR 04R00 National AN for GR
- NO 01R00 National AN for N
- NO 02R00 National AN for N
- P 03R00 National AN for P
- P 08R00 National AN for P

Network Compatibility Declaration

The manufacturer declares that the equipment has been designed to operate in the public switched telephone networks (PSTN) in the following countries:

- Austria
- Belgium
- Bulgaria
- Cyprus
- Czech
- Denmark
- Estonia
- Finland
- France
- Germany
- Greece
- Hungary
- Iceland
- Ireland
- Italy
- Latvia
- Liechtenstein
- Lithuania
- Luxembourg
- Malta
- Norway
- Poland
- Portugal
- Romania
- Slovakia
- Slovenia
- Spain
- Sweden
- Switzerland
- The Netherlands
- United Kingdom

Trademark Information

- Microsoft, Windows, Windows Server, Internet Explorer, Excel and PowerPoint are registered trademarks or trademarks of Microsoft Corporation in the U.S.A. and/or other countries.
- Adobe Acrobat, Adobe Reader and PostScript are trademarks of Adobe Systems, Incorporated.
- Ethernet is a registered trademark of Xerox Corporation.
- IBM and IBM PC/AT are trademarks of International Business Machines Corporation.

All other company and product names in this Operation Guide are trademarks or registered trademarks of their respective companies. The designations™ and ® are omitted in this guide.

2 Before Using the Fax Machine

This chapter explains the following topics:

Part Names and Functions	2-2
Machine	2-2
Operation Panel	2-4
Touch Panel	2-5
Enter key and Quick No. Search key	2-6
Quick Setup Wizard (Fax Setup)	2-7
Fax setup items	2-7
Fax setup procedure	2-8
Setting Date and Time	2-9
PBX Setting (Europe only)	2-10
Registering Destinations in the Address Book	2-11
Adding a Destination (Address Book)	2-11
Adding a Destination on One Touch Key	2-17

Part Names and Functions

Machine

This chapter explains the names of parts when the machine is used as a fax machine. For the parts required when functions other than FAX are used, refer to the following:

➔ Machine's *Operation Guide*

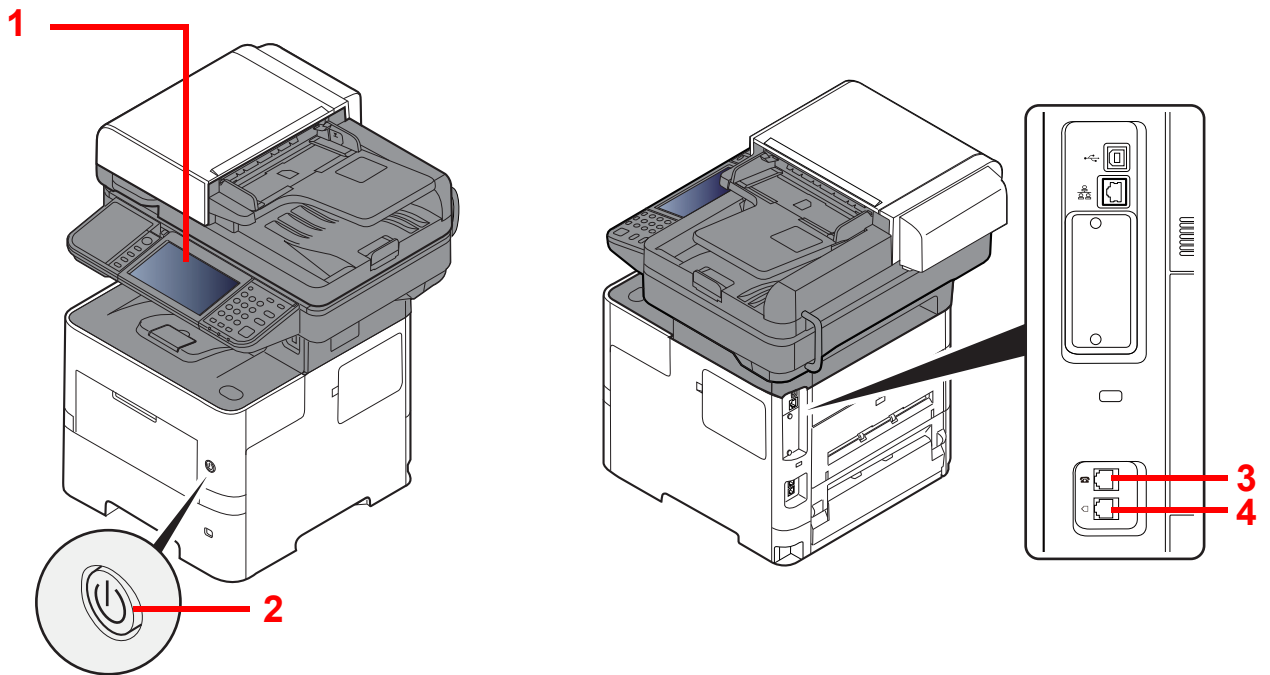

1	Operation panel	Perform the fax operation with this panel.
2	Power switch	Set this switch to the ON side when performing the fax or copier operation. The touch panel lights to enable operation.
3	TEL connector	When using a commercially available telephone set, connect the modular cord to this connector.
4	LINE connector	Connect the modular cord for the telephone line to this connector.



IMPORTANT



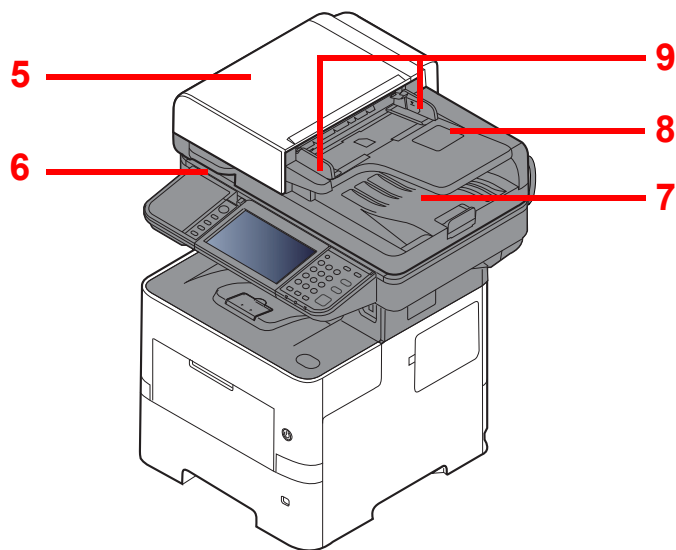

You cannot automatically receive a fax when the power switch is turned off.

Document Processor



5	Top cover	Open this cover when the original jammed in the Document Processor.
6	Opening handle	Hold this handle when opening or closing the Document Processor.
7	Original table	Stack the sheet originals on this table.
8	Original eject table	Read originals are ejected onto this table.
9	Original width guides	Adjust these guides according to the original width.

Operation Panel

	Displays the Home screen.		Function Key: These keys enable various functions and applications, including copy and scan, to be registered. ➔ Function Key Assignment (page 8-6)
Status/Job Cancel 	Displays the Status/Job Cancel screen.	 	













Touch panel.
 Displays buttons for configuring machine settings.

Blinks while printing or sending/receiving.

Blinks while the machine is accessing the machine memory, fax memory or USB memory (general purpose item).

Lights or blinks when an error occurs and a job is stopped.

System Menu / Counter 	Displays the System Menu/Counter screen.	Authentication/Logout 	Authenticates user switching, and exits the operation for the current user (i.e. log out).	Energy Saver 	Puts the machine into Sleep Mode. Recovers from Sleep if in Sleep Mode.
	Numeric keys. Enter numbers and symbols.	Clear 	Clears entered numbers and characters.	Reset 	Returns settings to their default states.
		Quick No. Search 	Specifies registered information such as address numbers, user IDs and program numbers by number.	Stop 	Cancels or pauses the job in progress.
		Enter 	Finalizes numeric key entry, and finalizes details during setting of functions. Operates linked with the on-screen [OK].	Start 	Starts copying and scanning operations and processing for setting operations.

Touch Panel

Home Screen



This screen is displayed by selecting the [Home] key on the operation panel. Selecting an icon will display the corresponding screen.

You can change the icons to display on the Home screen as well as its background.

➔ Machine's *Operation guide*

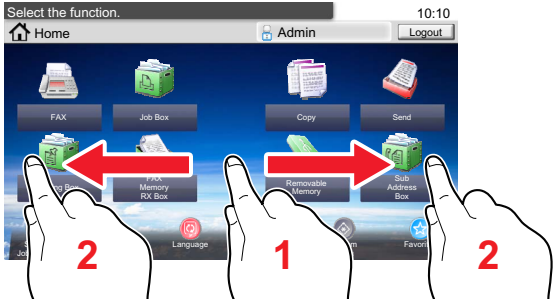

* The appearance may differ from your actual screen, depending on your configuration and option settings.

No.	Item	Description
1	Message	Displays the message depending on the status.
2	Desktop	Displays a maximum of 40 function icons* including the functions registered in favorite. Icons that are not displayed on the first page will appear by changing the page.
3	Screen-switching keys	Use these buttons to switch between desktop pages. <div style="display: flex; align-items: center;"> <div style="margin-right: 10px;">  <p>NOTE</p> </div> <div> <p>You can also switch views by touching the screen and moving the finger sideways (i.e. swiping).</p> </div> </div> 
4	Taskbar	Displays a maximum of 8 task icons.
5	[Logout]	Logs out the current user. This is displayed when user login administration is enabled.
6	Login User Name	Displays the logged-in user name. This is displayed when user login administration is enabled. Selecting "Login User Name" will display the information of the logged-in user.
7	Status Icon (Wi-Fi)	The icon is displayed when Wi-Fi is connected. When Wi-Fi is not connected, "  " is displayed.
8	Status Icon (Error)	The icon is displayed during network startup or error.

* A maximum of 42 icons can be displayed on products with the fax function installed. A maximum of 16 icons can be displayed for installed applications.

Operating the touch panel

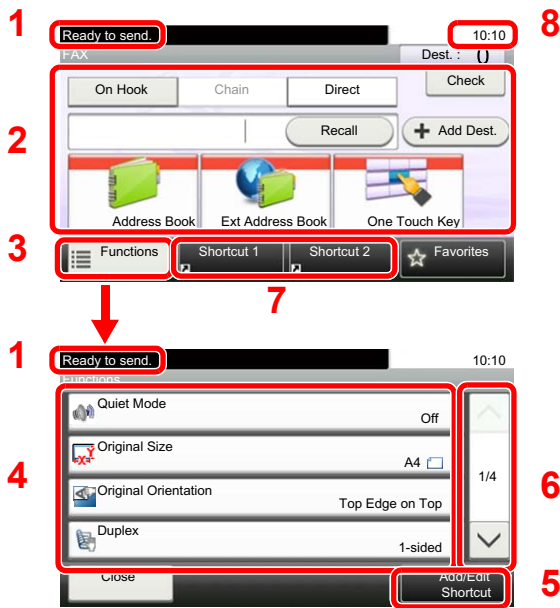

- 1 Displays the status of the equipment as well as necessary operation messages.
- 2 Enters destinations.
- 3 Configures function settings.
- 4 Displays available functions and settings.
- 5 Registers functions as shortcuts.
- 6 Scrolls up and down when the list of values cannot be displayed in its entirety on a single screen.
- 7 Displays shortcuts.
- 8 Displays the date and time and number of destinations.

Enter key and Quick No. Search key

This section explains how to use the [Enter] key and [Quick No. Search] key on the operation panel.

Using the [Enter] key (↵)

The [Enter] key has the same function as the key with the Enter mark (↵), such as the [OK ↵] key and the [Close ↵].

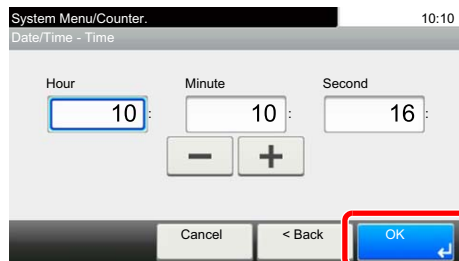

Using the [Quick No. Search] key (⋮)

The [Quick No. Search] key is used when using the numeric keys to directly enter the number, for example, when specifying the destination for the transmission using a speed-dial number.

For more information on speed dialing, refer to the following:

➔ [Using the Speed Dial key \(page 3-10\)](#)

Quick No.
Search

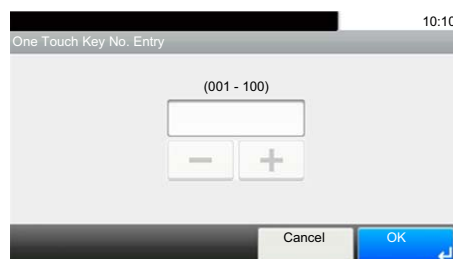

Quick Setup Wizard (Fax Setup)

In quick setup mode, a wizard is used to configure the following settings. Be sure to complete the settings before using the fax system.

Fax setup items

Step	Setting item	Description	Reference Page
1. Dialing/RX Mode	Dialing Mode	Select the dialing mode according to the line type.	8-8
	Reception Mode	Select the reception mode.	8-9
	Auto (DRD)	Select the reception pattern.	8-9
2. Local Fax Info.	Local FAX Name	Register the local fax name printed on the fax on the receiving system.	8-7
	Local FAX Number	Enter the local fax number to be printed on the fax on the receiving system.	8-7
	Local FAX ID	Enter the local fax ID. The local fax ID can limit other parties with which you can communicate. Enter the four-digit local FAX ID number.	8-7
	TTI	Select whether or not to print the local fax information on the fax on the receiving system.	8-7
3. Sound	Speaker Volume	Set the volume when selecting [On Hook] . Speaker Volume: Volume of the built-in speaker when the line is connected by selecting [On Hook] .	8-5
	Monitor Volume	Set the monitor volume. Monitor Volume: Volume of the built-in speaker when the line is connected without selecting [On Hook] such as in memory transmission.	8-5
	Job Finish Buzzer	Emit a sound when a print job is normally completed.	8-5
4. Rings	Normal	Set number of times to let phone ring before answering a call.	8-9
	Answering Machine	Set number of times to let phone ring before taking over from the answering machine.	8-9
	FAX/TEL Switch	Set number of times to let phone ring before switching the FAX and the phone.	8-9
5. Redial	Retry Times	Set the number of redials.	8-8



NOTE

The settings can be changed in the system menu.

➔ [Default fax settings \(page 8-2\)](#)

Fax setup procedure

 **NOTE**

If the user authentication screen appears, enter your login user name and login password and select [**Login**].

The factory default login user name and login password are set as shown below.

	P-4536i MFP	P-5536i MFP	P-6036i MFP
Login User Name:	4500	5500	6000
Login Password:	4500	5500	6000

1 Display the screen.

[System Menu/Counter] key > [Quick Setup Wizard] > [FAX Setup]

2 Configure the function.

Start the wizard. Follow the instructions on the screen to configure settings. [**Next>**]

End	Exits the wizard.
<< Previous	Returns to the previous item.
Skip >>	Advances to the next item without setting the current item.
Next >	Advances to the next screen.
< Back	Returns to the previous screen.

Setting Date and Time

Set the local date and time at the place of installation.

When you send a fax using the transmission function, the date and time as set here will be printed in the header of the fax. Set the date, time and time difference from GMT of the region where the machine is used.

 **NOTE**

Be sure to set the time difference before setting the date and time.

The date and time are set using the Machine Setup Wizard when the machine is turned on for the first time after installation.

If the login user name entry screen appears during operations, log in by referring to the machine's *Operation Guide* for Administrator User Name and Password.

The factory default login user name and login password are set as shown below.

	P-4536i MFP	P-5536i MFP	P-6036i MFP
Login User Name:	4500	5500	6000
Login Password:	4500	5500	6000

1 Display the screen.

[System Menu/Counter] key > [Date/Timer/Energy Saver]

2 Configure the settings.

[Time Zone] > [Date/Time] > [Date Format]

Item	Description
Time Zone	Set the time difference from GMT. Choose the nearest listed location from the list. If you select a region that utilizes summer time, configure settings for summer time.
Date/Time	Set the date and time for the location where you use the machine. If you perform Send as E-mail, the date and time set here will be displayed on the header. Value: Year (2000 to 2037), Month (1 to 12), Day (1 to 31), Hour (00 to 23), Minute (00 to 59), Second (00 to 59)
Date Format	Select the display format of year, month, and date. The year is displayed in Western notation. Value: Month/Day/Year, Day/Month/Year, Year/Month/Day

PBX Setting (Europe only)

When using this machine in environment in which PBX for connection to multiple phones for business use is installed, perform the following PBX setting.

 **NOTE**
Before connecting this machine to PBX, it is recommended to contact the company that installed the PBX system to request connection of this machine. Note that correct operation cannot be guaranteed in environment in which this machine is connected to PBX because the functions of this machine may be restricted.

Item	Setting value	Description
Exchange Selection	PSTN	Use when connecting this machine to a public switched telephone network (default).
	PBX	Use when connecting this machine to PBX.
Outside call number setting	0-9 00-99	Set a number to access an outside line. For the number, contact the PBX administrator.

Registering Destinations in the Address Book

Save frequently used destinations to the Address Book or One Touch Key. The saved destinations can be changed. The destinations are available for Send as E-mail, Send to Folder, and Fax Transmission.



NOTE

Registering and editing of the Address Book can also be done in Embedded Web Server RX.

➔ [Machine's Operation Guide](#)

Adding a Destination (Address Book)

Add a new destination to the Address Book. There are two registering methods, contacts and groups. When adding a group, enter the group name and select group members from the Address Book.

Adding a contact

A maximum of 200 contact addresses can be registered. Destination name, fax number, sub address communication, encryption, transmission start speed, and ECM can be registered for each destination.



NOTE

If user login administration is enabled, you can only edit destinations in the Address Book by logging in with administrator privileges.

Contact addresses can also be registered in the system menu.

1 Display the screen.

[FAX] on the Home screen > [Address Book] > [Menu] > [Add] > [Contact]

2 Enter the destination name.

1 Enter the destination name to be displayed on the Address Book > [Next >]



NOTE

Up to 32 characters can be entered.

For details on character entry, refer to the following:

➔ [Character Entry Method \(page 10-2\)](#)

2 To specify an Address Number, select [Address Number].

3 Use [+], [-] or numeric keys to enter a particular Address Number.

If you set "000" as the address number, the address is registered under the lowest available number.



NOTE

Address Number is an ID for a destination. You can select any available number for groups.

If you specify an address number that is already in use, an error message appears when you select [Save] and the number cannot be registered.

4 Select [OK].

3 Enter the fax number.

- 1 Select **[FAX]**.
- 2 Enter the fax number of the receiving system.

 **NOTE**

Up to 32 characters can be entered.

Use the numeric keys to enter a number.

➔ [Character Entry Method \(page 10-2\)](#)

Key	Description
Pause	Selecting this key adds about three seconds of waiting time during dialing. For example, when dialing the receiving system on an external line, you can use this method to insert a pause before resuming dialing after you dial a specific number.
Space	It is possible to enter half-width spaces in the entry of the destination number. This is useful when checking if the destination number has been entered correctly.
< >	Moves the cursor.
Backspace	To correct the fax number, select [Backspace] on the touch panel, and delete the digits one by one before reentering the fax number. To delete the number entirely, select the [Clear] key on the operation panel.

4 Select transmission settings.

The transmission start speed, ECM, and encrypted transmission can be set.

- 1 Select **[Detail Settings]**.
- 2 Select **[TX Start Speed]**, **[ECM]** and **[Encrypted Transmission]** and set each item then select **[OK]**.

Key		Description
Detail Settings	TX Start Speed	This is set to change the transmission start speed. Select the speed from 33,600 bps, 14,400 bps, and 9,600 bps.  NOTE Normally the default setting should be used.
	ECM	ECM is a communication mode specified by the ITU-T (International Telecommunication Union) that retransmits data when an error occurs. Fax machines that have ECM mode check for errors as they communicate, preventing distortion of the image due to noise on the line and other conditions.
	Encrypted Transmission	This is set when using encrypted transmission to send the data. ➔ Using the Encrypted Transmission (page 5-26)

5 Set a sub address.

To use sub address communication, a sub address and password must be registered.

- 1 Select [**Sub Address**].
- 2 Select [**Sub Address**] and [**Password**] and enter each item then select [**OK**].
For the procedure for setting a sub address, refer to the following:

➔ [Sub Address Transmission \(page 5-14\)](#)

6 Register the destination.

- 1 Select [**OK**].
- 2 Check if the destination entry is correct and select [**Save**]. The destination is added to the Address Book.

Adding a Group

Compile two or more contacts into a group. Designations in the group can be added at the same time. When adding a group, a maximum of 50 groups can be added in the Address Book.

Before adding a group in the Address Book, the contacts to be included in the group must be added first.



NOTE

If user login administration is enabled, you can only edit destinations in the Address Book by logging in with administrator privileges.

Designations in the group can also be registered in the system menu.

1 Display the screen.

[FAX] on the Home screen > [**Address Book**] > [**Menu**] > [**Add**] > [**Group**]

2 Enter the group name.

- 1 Enter the group name to be displayed on the Address Book > [**Next >**]



NOTE

Up to 32 characters can be entered.

For details on character entry, refer to the following:

➔ [Character Entry Method \(page 10-2\)](#)

- 2 To specify an Address Number, select [**Address Number**].
- 3 Use [**+**], [**-**] or numeric keys to enter a particular Address Number.
If you set "000" as the address number, the address is registered under the lowest available number.



NOTE

Address Number is an ID for a destination. You can select any available number for groups.

If you specify an address number that is already in use, an error message appears when you select [**Save**] and the number cannot be registered.

- 4 Select [**OK**].

3 Select the members (destinations).

- 1 [Member] > [+]



- 2 Select destinations (contacts) to add to the group.

NOTE

Select the checkbox to select the desired destination from the list. The selected destinations are indicated by a checkmark in the check box.

To cancel a selection, select the corresponding checkbox to clear the check mark.

Destinations can be sorted or searched by destination name or address number.

➔ [Choosing from the Address Book \(page 3-9\)](#)

- 3 Select [OK].
The destinations with a checkmark displayed in the checkbox will be added to the members.
- 4 Check if the selected destination was added to the group and select [End].

4 Register the group.

Select [Save].

Now the group is added to the Address Book.

Editing and Deleting Address Book Entries

Edit and delete the destinations (contacts) you added to the Address Book.

Changing the Address Book

1 Display the screen.

- 1 [FAX] on the Home screen > [Address Book] > [Menu] > [Edit]
- 2 Select the destination (contacts) or group to edit.

NOTE

Destinations can be sorted or searched by destination name or address number.

➔ [Choosing from the Address Book \(page 3-9\)](#)

2 To edit the destination.

Editing a Contact

- 1 Change "Address Number", "Name" and destination type and address.
How to change, refer to the following:

➔ [Adding a contact \(page 2-11\)](#)

- 2 After you have completed the changes, [Save] > [Yes]

Editing a Group

- 1 Change "Address Number" and "Name".

➔ [Adding a Group \(page 2-13\)](#)

- 2 Select [Member].

- 3 To delete any destination from the group, select the destination and select [🗑️].
Select [Yes] in confirmation screen.

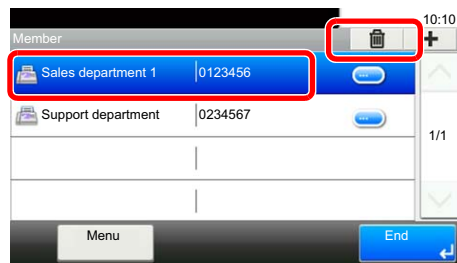

- 4 To add the destination, select [+]. Select the members to be added to add them.



- 5 After you have completed the change of members, select [End].

- 6 After you have completed the changes, [Save] > [Yes].
The changed group is registered.

Deleting a Contact or Group

1 Display the screen.

[FAX] on the Home screen > [Address Book] > [Menu] > [Delete]

2 To delete

- 1 Select the destination (contacts) or group to delete.
- 2 Select [Yes].

Printing Address List

You can print the list of destinations registered in the Address Book.

You can sort the list in the order of index or address numbers of the destinations.

1 Display the screen.

[System Menu/Counter] key > [Address Book/One Touch] > [Print List]

2 Print

[FAX List (Index)] or [FAX List (No.)] > [Yes]

The list is printed.

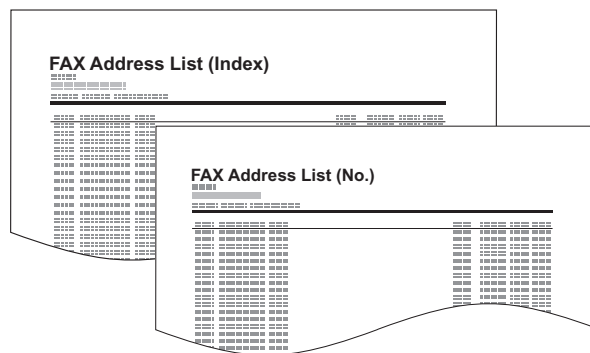

Adding a Destination on One Touch Key

Add a new destination (contact or group) on One Touch Key.

Adding a Destination

Add a new destination (contact or group). A maximum of 100 destinations can be registered. Register fax destinations in the Fax screen.

To register a destination to a One Touch Key, it must first be registered in the Address Book. Register one or more destinations as needed before proceeding.

1 Display the screen.

[System Menu/Counter] key > [Address Book/One Touch] > [One Touch Key]

2 Add a One Touch Key.

1 Select the One Touch Key to be added and select [+].

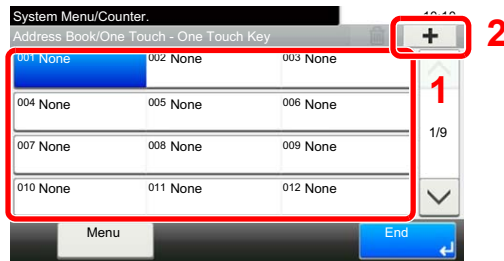

2 Select one destination (contact or group) from the Address Book.

NOTE

Destinations can be sorted or searched by destination name or address number.

➔ [Choosing from the Address Book \(page 3-9\)](#)

3 Enter the One Touch Key name displayed in the send base screen > [Next >].

NOTE

Up to 24 characters can be entered.

For details on character entry, refer to the following:

➔ [Character Entry Method \(page 10-2\)](#)

4 Select [Save].

The destination is added to the Address Book.

Editing and Deleting One Touch Key

Edit and delete the destinations you added to One Touch Key.

1 Display the screen.

[System Menu/Counter] key > [Address Book/One Touch] > [One Touch Key]
The procedure differs depending on the details to be edited.

2 Edit or delete the destination.

To edit the destination

- 1 Select the One Touch Key you wish to edit and select [Menu] > [Edit].
- 2 To change to a different destination, select [Destination] then select the destination and select [OK].
- 3 To change the name of the One Touch Key displayed on the basic screen, select [Name] then enter the name and select [OK].
- 4 [Save] > [Yes]
The destination is registered to the One Touch Key.

To delete

- 1 Select the One Touch Key you wish to delete and select [].

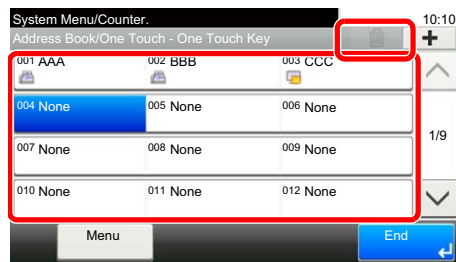

- 2 Select [Yes].

3 Sending Faxes

This chapter explains the following topics:

Basic transmission procedure	3-2
Checking the Send Status	3-4
Priority Override Send	3-4
Cancelling the Transmission	3-5
Using redial	3-6
Methods For Entering the Destination	3-7
Entering the destination fax number with the numeric keys	3-7
Choosing from the Address Book	3-9
Choosing by One Touch Key	3-10
Using the Speed Dial key	3-10
Broadcast Transmission	3-11
Login/Logout	3-13
Logging in when User Accounting has been Enabled	3-13
Logging in when Job Accounting has been Enabled	3-14
Fax transmission functions	3-15
Quiet Mode	3-16
Original Size	3-16
Original Orientation	3-16
Duplex	3-16
FAX TX Resolution	3-17
Density	3-17
Original Image	3-17
Continuous Scan	3-18
FAX Direct Transmission	3-18
Cancelling Direct Transmission	3-18
Manual Send	3-19
FAX Delayed Transmission	3-20
Cancelling and Sending Delayed Transmissions (Queued)	3-21
Standby Transmission	3-21
Interrupt Send	3-22
Job Finish Notice	3-23
File Name Entry	3-23
Long Original	3-23
FAX TX Report	3-23
Using chain dial	3-24
Using favorites	3-26

Basic transmission procedure

The basic procedure for using the fax system is explained below.

1 Select [FAX] on the Home screen.

The base screen for fax appears.

2 Place the originals.

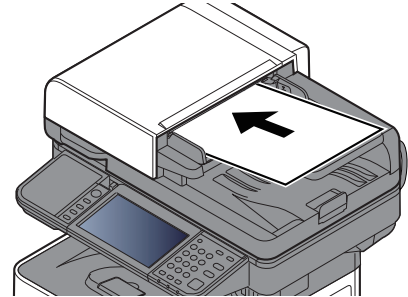
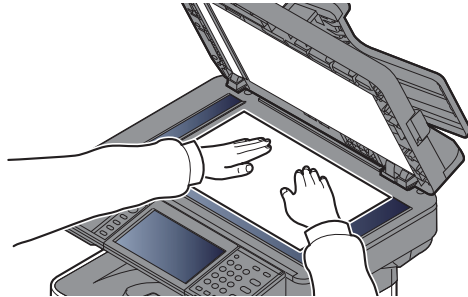

For placing originals, refer to the following:

➔ [Machine's Operation Guide](#)

3 Select the transmission method.

There are two transmission methods: memory transmission and direct transmission.

Memory transmission: The original is scanned into memory before communication starts. Memory transmission is selected by default.

Direct transmission: The destination is dialed and communication starts before the original is scanned.

Select [**Direct**] to change the transmission method to direct transmission. The key will be highlighted on the touch panel. If the [**Direct**] is selected in the highlighted state, the transmission method will change to memory transmission.

➔ [FAX Direct Transmission \(page 3-18\)](#)

4 Specifying destination.

Specify the transmission destination.

➔ [Methods For Entering the Destination \(page 3-7\)](#)

5 Selecting the functions.

Select [**Functions**], and set transmitting functions that can be used.

➔ [Fax transmission functions \(page 3-15\)](#)

6 Send Start.

Press the [**Start**] key.

When scanning finishes, transmission starts.

When originals are placed in the document processor

After originals placed in the document processor are scanned and stored in the memory, the receiving system is dialed.

When originals are placed on the glass surface

After originals placed on the glass surface are scanned and stored in the memory, the receiving system is dialed.



NOTE

When continuous scan is set, you can continue with scanning of a next original after an original on the glass surface has been stored in memory. Every time one page is scanned, you perform an operation to allow continued scanning, and after all the originals have been stored in memory, the receiving system is dialed.

➔ [Continuous Scan \(page 3-18\)](#)

Checking the Send Status

1 Select the **[Status/Job Cancel]** key.

2 Display the send job status screen.

Select **[Send Job Status]**.

The list of accepted time, destination, and status are displayed for each job.

Priority Override Send

A fax job waiting to be sent can be sent by priority override.

1 Select the **[Status/Job Cancel]** key.

2 Select the job to be sent by priority override.

1 Select **[Send Job Status]**.

2 Select the fax job to be sent by priority override and select **[Menu]** > **[Priority Override]** > **[Yes]**.

The selected fax job is sent by priority override and other fax jobs are moved down in the transmission queue.



NOTE

If a fax job is in progress, the priority override fax job will be sent after the job in progress is completed.

If a broadcast transmission job is in progress...

If a fax job to multiple destinations (broadcast transmission) is in progress, the priority override job will be sent when transmission to the current destination is completed. When the priority override job is completed, transmission to the remaining destinations will resume.

However, if the priority override job is a broadcast transmission, the priority override job will not start until the current broadcast transmission job is finished.

Cancelling the Transmission

The method for cancelling communication with this machine differs depending on the transmission method (memory transmission or direct transmission) and communication form. Methods of cancelling in various cases are explained here.

Cancelling Memory Transmission (while originals are being scanned)

1 Select the [Stop] key.

During memory transmission, to cancel scanning while originals are being scanned, select the [Stop] key on the operation panel, or select [Cancel] on the touch panel.

Scanning of originals is canceled, and the originals are ejected. When originals remain in the document processor, take them out from the original output table.

Cancelling Memory Transmission (during communication)

NOTE

Even if transmission is canceled, there is a possibility that pages scanned prior to cancellation were sent to the receiving party. Check with the receiving party to see if pages were accidentally sent.

1 Select the [Status/Job Cancel] key.

2 Canceling Transmission.

1 Select [Send Job Status].

2 Select the transmission job that you want to cancel and select [Cancel] > [Yes] Cancel the transmission.

NOTE

In some cases, transmission may take place even if the [Stop] key or [Cancel] is selected.

Cancelling Transmission (during communication)

Follow this procedure to break the connection and stop transmission/reception.

1 Select the [Status/Job Cancel] key.

2 Disconnection of communication.

[FAX] > [Line Off]

NOTE

To cancel direct transmission, delayed transmission, or polling transmission, refer to the section for that function.

To cancel direct transmission, refer to the following:

➔ [Cancelling Direct Transmission \(page 3-18\)](#)

To cancel a delayed transmission or send a fax by immediate transmission, refer to the following:

➔ [Cancelling and Sending Delayed Transmissions \(Queued\) \(page 3-21\)](#)

To cancel polling transmission, refer to the following:

➔ [Polling Communication \(page 5-15\)](#)

Using redial

Redial is a function allowing you to dial the last entered number once again.

Use this when the receiving system does not respond when you have tried to send a fax. When you want to send the fax to the same receiving system, select **[Recall]**, and you can call the receiving system you dialed on the destination list.

1 Select **[Recall]**.

2 Press the **[Start]** key.

The transmission will start.



NOTE

Recall information is canceled in the following conditions.

- When you turn the power off
- When you send a next fax (new recall information is registered)
- When you log out

Methods For Entering the Destination

Entering the destination fax number with the numeric keys

The procedure for entering the destination fax number with the numeric keys is explained below.

 **NOTE**

If *New Destination Entry(FAX)* is set to **[Prohibit]**, it is not possible to directly enter a fax number. Select the destination from the Address Book or the One Touch Key.

➔ [New Destination Entry\(FAX\) \(page 8-10\)](#)

1 Display the fax number entry screen.

Select **[Add Dest.]**.

 **NOTE**

Pressing the number with the numeric keys changes the screen to the fax number entry screen.

2 Enter the fax number of the receiving system.

 **NOTE**

Up to 64 digits can be entered.

Use the numeric keys to enter a number.

Key	Description
Pause	Selecting this key adds about three seconds of waiting time during dialing. For example, when dialing the receiving system on an external line, you can use this method to insert a pause before resuming dialing after you dial a specific number.
Space	It is possible to enter half-width spaces in the entry of the destination number. This is useful when checking if the destination number has been entered correctly.
< >	Moves the cursor.
Backspace	To correct the fax number, select [Backspace] on the touch panel, and delete the digits one by one before reentering the fax number. To delete the number entirely, select the [Clear] key on the operation panel.

3 Select transmission settings.

Sub address communication, encrypted transmission, transmission start speed and ECM can be set.

It is possible to change the transmission settings by selecting [**On Hook**], [**Sub Address**] or [**Detail Settings**].

Key		Description
On Hook		<p>Select [On Hook] to connect to the telephone line. When the FAX number has been entered, the machine starts dialing to the receiving system. After selecting this key, you can dial the number of the receiving system using the numeric keys.</p> <p>➔ Manual Send (page 3-19)</p>
Sub Address		<p>Set this to transmit using a Sub Address.</p> <p>➔ Sub Address Transmission (page 5-14)</p>
Detail Settings	TX Start Speed	<p>This is set to change the transmission start speed. Select the speed from 33,600 bps, 14,400 bps, and 9,600 bps.</p> <p> NOTE Normally this should be used with the default setting.</p>
	ECM	<p>ECM is a communication mode specified by the ITU-T (International Telecommunication Union) that retransmits data when an error occurs. Fax machines that have ECM mode check for errors as they communicate, preventing distortion of the image due to noise on the line and other conditions.</p>
	Encrypted Transmission	<p>This is set when using encrypted transmission to send the data.</p> <p>➔ Encryption (page 5-23)</p>

4 Select [OK].

Entry of the destination finishes.



NOTE

When *On* is selected in *Entry Check for New Dest.*, a confirmation screen is displayed for the entered FAX number. Re-enter the same FAX number and select [**OK**].

➔ *Machine's Operation Guide*

Select [**Next Dest.**] to enter the next fax number.

➔ [Broadcast Transmission \(page 3-11\)](#)

In addition to a fax, you can include e-mail transmission and folder (SMB/FTP) transmission to send as one job.

➔ *Machine's Operation Guide*

Choosing from the Address Book

Select a destination registered in the Address Book.

NOTE

For more information about how to register destinations in the Address Book, refer to the following:

➔ [Registering Destinations in the Address Book \(page 2-11\)](#)

For details on the external address book, refer to the following:

➔ [Embedded Web Server RX User Guide](#)

1 Display the screen.

Select [**Address Book**].

2 Select the destination.

Select the checkbox to select the desired destination from the list. The selected destinations are indicated by a checkmark in the check box.

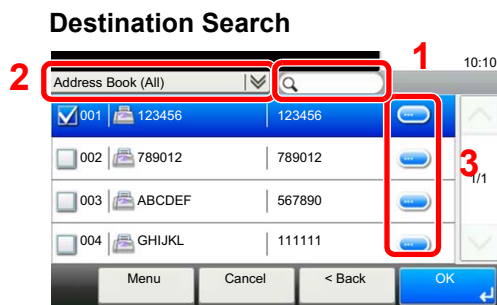

1 Searches by destination name.

2 Advanced search by type of registered destination (All, FAX or Group).

3 Displays details for individual destinations.

You can specify a destination by address number by selecting the [**Quick No. Search**] key.

You can also select [**Menu**] to perform a more detailed search.

Narrow Down: Advanced search by type of registered destination (All, FAX or Group).

Search (Name) and Search (No.): Searches by destination name or address number.

Sort (Name) and Sort (No.): Sorts the list by destination name or address number.

NOTE

You may choose multiple destinations.

To cancel a selection, select the corresponding checkbox to clear the check mark.

3 Select [**OK**].

Accept the destinations.

Choosing by One Touch Key

Select the destination using the One Touch Key.

NOTE

For more information on adding One Touch Key, refer to the following:

➔ [Adding a Destination on One Touch Key \(page 2-17\)](#)

1 Display the screen.

Select [**One Touch Key**].

2 Select the destination.

1 Select the One Touch Key where the destination is registered.

NOTE

You can specify a One Touch Key by one-touch number by selecting the [**Quick No. Search**] key.

2 Select [**OK**].
Accept the destinations.

Using the Speed Dial key

You can designate a three-digit (001 to 100) One Touch Key number (speed dial) to select the destination.

NOTE

For more information on adding One Touch Key, refer to the following:

➔ [Adding a Destination on One Touch Key \(page 2-17\)](#)

1 Display the screen.

Select [**One Touch Key**].

2 Enter a speed dial number.

1 Select the [**Quick No. Search**] key.

2 Enter the One Touch Key number (speed dial number) with the numeric keys.

3 Select [**OK**].
The entered destination is selected.

4 Select [**OK**].
Accept the destinations.

Broadcast Transmission

This function allows you to send the same originals to several destinations in one operation. The machine stores (memorizes) originals to send in memory temporarily, and automatically repeats dialing and transmission to the set destination afterwards.

NOTE

When using a group for the destination, you can send originals to up to 100 destinations in one operation.

You can use this function together with sub address communication and delayed transmission.

When direct transmission has been selected, it changes to memory transmission at the time of transmission.

1 Select **[FAX]** on the Home screen.

2 Specify the destination.

Enter the fax number

NOTE

If *New Destination Entry(FAX)* is set to **[Prohibit]**, it is not possible to directly enter a fax number. Select the destination from the Address Book or the One Touch Key.

➔ [New Destination Entry\(FAX\) \(page 8-10\)](#)

1 Select **[Add Dest.]**.

2 Enter the fax number of the receiving system.

NOTE

Up to 64 digits can be entered.

Use the numeric keys to enter a number.

3 Select **[Next Dest.]**.
Another fax number can be entered.

4 When all destinations have been entered, select **[OK]**.

NOTE

When *On* is selected in *Entry Check for New Dest.*, a confirmation screen is displayed for the entered FAX number. Re-enter the same FAX number and select **[OK]**.

➔ *Machine's Operation Guide*

Select the destination from the Address Book

1 Select **[Address Book]**.

2 Select the checkboxes of all destinations and select **[OK]**.

NOTE

For details of the Address Book, refer to the following:

➔ [Choosing from the Address Book \(page 3-9\)](#)

Select the destination from the One Touch Key

- 1 Select [**One Touch Key**].
- 2 Select all destinations and select [**OK**].



NOTE

For details of One Touch Key, refer to the following:

➔ [Choosing by One Touch Key \(page 3-10\)](#)

- 3 **After selecting all the destinations, press the [Start] key.**

Login/Logout

Logging in when User Accounting has been Enabled

When user accounting has been enabled, you need to enter a User ID and Password to use the machine.

Normal login

1 Enter the login user name and login password to login.

- 1 If this screen is displayed during operations, select **[Keyboard]** to enter the login user name.

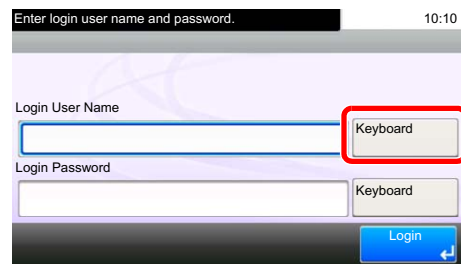

➔ [Character Entry Method \(page 10-2\)](#)

- 2 **[Password]** > Enter the login password > **[OK]**

NOTE

If **[Network Authentication]** is selected as the user authentication method, authentication destinations are displayed and either **[Local]** or **[Network]** can be selected as the authentication destination.

2 Select **[Login]**.

Simple Login

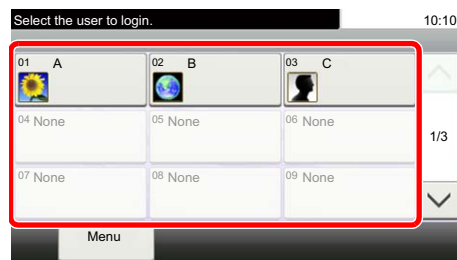

If this screen is displayed during operations, select a user and log in.

NOTE

If a user password is required, an input screen will be displayed.

➔ [Machine's Operation Guide](#)

Logout

Authentication/
Logout



To logout from the machine, select the [**Authentication/Logout**] key to return to the login user name/login password entry screen.

Logging in when Job Accounting has been Enabled

When job accounting has been enabled, you need to enter an Account ID when using the machine.

Login

- 1 In the screen below, enter the account ID using the numeric keys and select [**Login**].



NOTE

If you entered a wrong character, select the [**Clear**] key and enter the account ID again.

If the entered account ID does not match the registered ID, a warning beep will sound and login will fail. Enter the correct account ID.

By selecting [**Check Counter**], you can refer to the number of pages printed and the number of pages scanned.

Logout

Authentication/
Logout



When the operations are complete, select the [**Authentication/Logout**] key to return to the account ID entry screen.

Fax transmission functions

Select [Functions] to display the functions. Select [^] or [v] to change the screen.

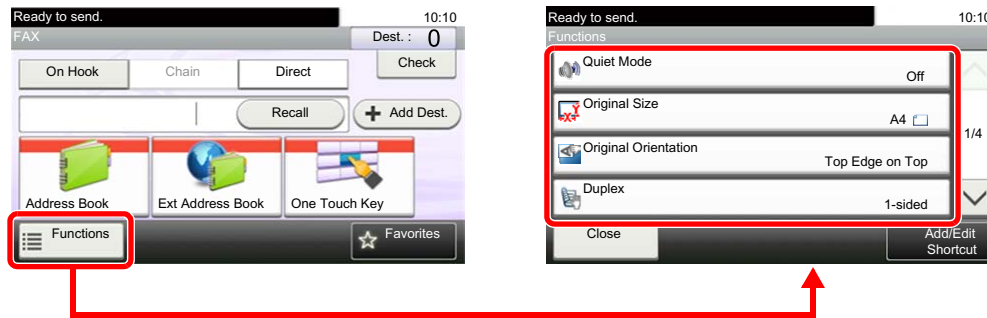

Function	Description	Reference Page
Quiet Mode	Lower print and scan speed for quiet processing. Select this mode when the running noise is uncomfortable.	3-16
Original Size	Specify the original size to be scanned.	3-16
Original Orientation	Select the orientation of the original document top edge to scan correct direction.	3-16
Duplex	Automatically scan 2-sided originals.	3-16
FAX TX Resolution	Set the resolution at which to scan originals.	3-17
Density	Adjust density.	3-17
Original Image	Select original image type.	3-17
Continuous Scan	Scan a large number of originals separately and then produce as one job.	3-18
File Name Entry	Adds a file name.	3-23
Long Original	Reads long-sized original documents using a document processor.	3-23
Job Finish Notice	Send notice by e-mail when a job is complete.	3-23
FAX Delayed Transmission	Specify a time for transmission.	3-20
FAX Direct Transmission	Connect to the destination first and then scan the original.	3-18
Polling Communication	This function allows you to start automatic transmission of a document saved in the sending machine by dialing from the receiving machine.	5-15
FAX TX Report	Print transmission results after transmission.	3-23

Other transmission functions

Function	Description	Reference Page
Standby Transmission	During a communication, you can scan originals and schedule a next transmission.	3-21
Interrupt Send	During communication, when you scan originals by selecting direct transmission, you can use interrupt send.	3-22
Sub Address Box Function	Send a fax using the Sub Address communications function.	5-8
Encryption	The original is encrypted on the sending side and then sent.	5-23

Quiet Mode

Lower print and scan speed for quiet processing. Select this mode when the running noise is uncomfortable.

➔ Machine's *Operation Guide*

Original Size

Specify the original size to be scanned.

Item	Value
Metric	Select from A4, A5, A6, B5, B6, Folio, or 216×340 mm.
Inch	Select from Letter, Legal, Statement, Executive, or Oficio II.
Others	Select from 16K, ISO B5, Envelope #10, Envelope #9, Envelope #6, Envelope Monarch, Envelope DL, Envelope C5, Hagaki (Cardstock), Oufuku Hagaki (Return postcard), Youkei 4, Youkei 2, or Custom*.

* For instructions on how to specify the custom original size, refer to the following:

➔ Machine's *Operation Guide*



NOTE

Be sure to always specify the original size when using custom size originals.

Original Orientation

To scan the original in the correct orientation, specify which side of the original is the top. To set a 2-sided original, the orientation of the placed original must be set.

Duplex

Select the type and orientation of the binding based on the original.

Item			Description
1-sided			Set when using a 1-sided sheet original.
2-sided			Set when using a 2-sided sheet original that will be bound on the left or right.
Other Settings	Duplex	1-sided	Set when using a 1-sided sheet original.
		2-sided (Binding Left/Right)	Set when using a 2-sided sheet original that will be bound on the left or right.
		2-sided (Binding Top)	Set when using a 2-sided sheet original that will be bound at the top.
	Original Orientation*		Select the orientation of the original document top edge to scan correct direction.

* This function is not displayed when [1-sided] is selected.



NOTE

For direct transmission, you cannot use [2-sided].

FAX TX Resolution

Select fineness of images when sending FAX. The larger the number, the better the image resolution. However, better resolution also means larger file sizes and longer send times.

Item	Description	
400 × 400 dpi Ultra	when sending originals with minute characters and lines more finely	Typical character size: 6 point (example: Resolution Resolution)
200 × 400 dpi Super	when sending originals with minute characters and lines	Typical character size: 6 point (example: Resolution Resolution)
200 × 200 dpi Fine	when sending originals with relatively small characters and thin lines	Typical character size: 8 point (example: Resolution Resolution)
200 × 100 dpi Normal	when sending originals with standard size characters	Typical character size: 10.5 point (example: Resolution Resolution)



NOTE

The default setting is [200 × 100 dpi Normal]. The higher the resolution, the clearer the image, but the fax transmission time is longer.

Density

Adjust the density.



NOTE

When you want to increase the density of the original that has thin density, density needs to be adjusted to Darker. When you want to reduce the density of the original that has thick density, density needs to be adjusted to Lighter.

Original Image

Select original image type for best results.

Item	Description
Text+Photo	Best for mixed text and photo documents.
Photo	Best for photos taken with a camera.
Text	Best for documents that are mostly text.
Light Text/Line	Clearly reproduces faint characters written in pencil, etc., and thin lines on map originals or diagrams.
Text (for OCR)	Scanning produces an image that is suitable for OCR.

Continuous Scan

Scan a large number of originals in separate batches and then produce as one job. Originals will be scanned continuously until you select [**Finish Scan**].

FAX Direct Transmission

Scans all originals into memory, then dials and sends. Scanning of the originals starts after the connection is made with the receiving system, allowing you to verify that each page of the fax has been properly sent.

Setting for Direct transmission	Description
On	Starts direct transmission. Dials the receiving system, and after the communication has started, originals are scanned.
Off	Starts memory transmission. After originals are scanned into memory, the communication starts.



NOTE

In direct transmission, you can designate only one destination for one transmission.

In the basic screen for sending, select [**Direct**]. This selects the direct transmission method and the keys on the touch panel are highlighted.

Cancelling Direct Transmission

During direct transmission, to cancel communication during transmission, select the [**Stop**] key on the operation panel or [**Cancel**] on the touch panel. The originals that have been scanned are ejected, and the screen returns to the send default screen. When originals remain in the document processor, take them out.



NOTE

In some cases, transmission may take place even if the [**Stop**] key or [**Cancel**] is selected.

Manual Send

This method allows you to send originals by pressing the **[Start]** key after confirming that the telephone line has connected to the receiving system.

 **NOTE**
Connecting a telephone set (commercially available product) to this machine enables you to talk with the person at the receiving system before sending originals.

- 1** Select **[FAX]** on the Home screen.
- 2** Place the originals.
- 3** Select **[On Hook]**.
- 4** Use the numeric keys to enter the number of the receiving system.

 **NOTE**
To cancel the operation, select **[Line Off]**.

- 5** Press the **[Start]** key.
When you hear the fax tone, the telephone line has connected to the receiving system. Press the **[Start]** key. Transmission begins.

FAX Delayed Transmission

Set a send time. You can use delayed transmission together with the broadcast transmission function, etc.

Item	Description
Off	Does not use the delayed transmission.
On	Uses the delayed transmission.
Start Time	Set the time from between 00:00 and 23:59 in one-minute increments.

 **IMPORTANT**
If the current time displayed on the touch panel is not correct, you cannot send originals correctly at the preset time. In this case, adjust the time.
 ➔ [Setting Date and Time \(page 2-9\)](#)

 **NOTE**
 You cannot select direct transmission.
 You can set up to 30 destinations for delayed transmission.
 When two or more delayed transmissions are set for the same time, the communication will start in the order that the delayed transmissions have been set. When delayed transmissions have been set in reverse order, however, sending of originals to be sent to the same destination is prioritized over the ones to be sent to different destinations.
 You can cancel a delayed transmission any time before the specified transmission time. You can also send a delayed transmission before the specified time.
 ➔ [Cancelling and Sending Delayed Transmissions \(Queued\) \(page 3-21\)](#)

Batch Transmission Function

When fax originals to be sent to the same destination are set to the same transmission start time with delayed transmission, you can send up to 10 groups of originals using batch transmission. This function prevents repeated communication to the same destination and reduces the communication cost.

 **NOTE**
 You cannot send originals as a batch transmission in the case of direct transmission.
 In the case of broadcast transmission, when you have set two or more groups of originals to the same transmission start time, and each group includes the same receiving system fax number, you cannot send the originals as a batch transmission.
 When the transmission start time has come, and there are fax originals waiting for redial to the same receiving system, the waiting originals are also sent together as a batch transmission.
 When job accounting is ON, only the originals with the same account ID set using delayed transmission are sent as a batch transmission.

Cancelling and Sending Delayed Transmissions (Queued)

To cancel delayed transmissions that are queued, or to send delayed transmissions immediately rather than waiting for the specified time, use the procedure below.

1 Display the screen.

[Status/Job Cancel] key > [Scheduled Job]

2 Canceling a job and immediate transmission.

Canceling a job

Select the job you want to cancel and select [Cancel] > [Yes].
The selected job is deleted.

Immediate transmission

Select the job you want to send by immediate transmission, and select [Menu] > [Start Now] > [Yes].
The transmission will start.

Standby Transmission

During a communication, you can scan originals and schedule a next transmission. When the first communication is completed, the machine automatically starts the scheduled next transmission. When using standby transmission, you do not need to wait when a communication has prolonged due to broadcast transmission.



NOTE

Together with delayed transmission and interrupt send, up to 35 transmissions can be scheduled. You can use the broadcast transmission function.

1 Select [FAX] on the Home screen.

2 Place the originals.

3 Select the destination, and set transmitting functions if you want to use any.

4 Press the [Start] key.

Scanning of the originals starts, and the next transmission is scheduled.



NOTE

When *On* is selected in *Dest. Check before Send*, a destination confirmation screen is displayed when you press the [Start] key.

➔ [Confirmation Screen of Destinations \(page 7-10\)](#)

5 When the communication is completed, the scheduled transmission will begin.

Interrupt Send

During communication, when you scan originals by selecting direct transmission, you can use interrupt send. Even when the communication is prolonged due to broadcast transmission or a next transmission being scheduled, the machine will first send originals for which interrupt send has been set.

 **NOTE**
When the total number of standby transmissions and delayed transmissions has already reached 35, you cannot use interrupt send.

- 1 Select [FAX] on the Home screen.**
- 2 Load the originals to be sent using Interrupt Send.**
- 3 Select [Direct].**

For operation of direct transmission, refer to the following:

➔ [FAX Direct Transmission \(page 3-18\)](#)

- 4 Set the destination, and press the [Start] key.**

The originals are left in queue, and the transmission will start when transmission becomes possible.

 **NOTE**
When *On* is selected in *Dest. Check before Send*, a destination confirmation screen is displayed when you press the [Start] key.

➔ [Confirmation Screen of Destinations \(page 7-10\)](#)

To cancel transmission while waiting for interrupt send, select the [Stop] key on the operation panel or [Cancel] on the touch panel.

➔ [Cancelling Direct Transmission \(page 3-18\)](#)

- 5 When the interrupt send is completed, the canceled communication and standby transmission will automatically resume.**

Job Finish Notice

Send e-mail notice when a job is complete.

➔ [Machine's Operation Guide](#)

It is possible to attach an image to the e-mail notice.

➔ [Job Finish Notice Setting \(page 8-4\)](#)

File Name Entry

Add a file name. Additional information such as Job No. and Date and Time can also be set.

➔ [Machine's Operation Guide](#)

Long Original

Reads long-sized original documents using a document processor.

(Value: [Off] / [On])



NOTE

Only a single side of a long original cannot be scanned.

Originals of up to 915 mm/36-1/32" long can be scanned.

FAX TX Report

You can check whether FAX was transmitted properly by printing the report after transmission.

Item	Description
Off	Does not print reports.
On	Prints reports.
Error Only	Prints reports only if an error occurs.



NOTE

This setting is displayed if FAX TX Result Reports is set to [Specify Each Job].

➔ [Send Result Reports \(page 7-4\)](#)

Using chain dial

Chain dial is a function that allows you to dial by linking fax numbers of the receiving systems with a chain number created with a number common to several destinations.

By setting multiple phone numbers from several telephone companies to a chain number, you can later choose the one that costs the least to send the fax to a remote or international destination.

NOTE

It is convenient to register chain numbers that are used frequently to the Address Book or One Touch Key.

For registration to the Address Book, refer to the following:

➔ [Adding a Destination \(Address Book\) \(page 2-11\)](#)

For registration to One Touch Key, refer to the following:

➔ [Adding a Destination on One Touch Key \(page 2-17\)](#)

As an example, when using '212' as the chain number

1 Select the chain dial number

To use a One Touch Key, select the destination in which "212" is registered.

NOTE

To use the Address Book, select the destination in which "212" is registered as explained in *Choosing from the Address Book*.

➔ [Choosing from the Address Book \(page 3-9\)](#)

To enter using the numeric keys, select [**Add Dest.**], enter "212", and select [**OK**].

2 Select [**Chain**].

3 Enter the fax number to be added to the chain number.

Select fax number from the Address Book

1 Select [**Address Book**].

Multiple destinations can be selected.

2 When [**OK**] is selected, "212" is automatically added to all destinations.

For the procedure for selecting a destination in the address book, refer to the following:

➔ [Choosing from the Address Book \(page 3-9\)](#)

Select fax number from One Touch Key

1 Select [**One Touch**].

Multiple destinations can be selected.

2 When [**OK**] is selected, "212" is automatically added to all destinations.

Use the numeric keys to enter a fax number

- 1 Select [**Address Entry**].
- 2 "212" is already entered, so continue by entering the fax number.
- 3 [**Menu**] > [**Next Dest.**]
Another fax number can be entered. When all destinations have been entered, select [**OK**].



NOTE

When *On* is selected in *Entry Check for New Dest.*, a confirmation screen is displayed for the entered FAX number. Re-enter the same FAX number and select [**OK**].

▶ *Machine's Operation Guide*

Using favorites

A destination, transmission time, and other transmission settings can be registered as a favorites. After a favorites has been registered, it can be opened by simply selecting it from the Favorites screen. By registering using the wizard format, you can check each setting when transmitting.

For the procedure for registering a *favorites*, refer to the following:

➔ Machine's *Operation Guide*

1 Select [Favorites] on the Home screen.

2 Select a favorite.

When using the wizard mode

- 1 The registered screens are displayed in order. Make the desired settings and select [**Next**]. When all the settings are complete, the confirmation screen is displayed.



NOTE

To edit the settings, select [**<Back**] and make changes as desired.

- 2 Place the originals and press the [**Start**] key.

When using the program mode

Place the originals and press the [**Start**] key.

4 Receiving Faxes

This chapter explains the following topics:

FAX Automatic Reception	4-2
Reception Method	4-2
Checking and Changing the Reception Method	4-2
Flow of reception	4-3
Canceling reception (Disconnection of communication)	4-3
Manual Reception	4-4
Flow of reception	4-4
Fax reception functions	4-5
Fax reception settings	4-6
Duplex Printing	4-6
2 in 1 Print	4-6
Batch Print	4-6
Reception Date/Time	4-6
Media Type for Print Output	4-7

FAX Automatic Reception

When using this machine as a FAX-dedicated machine that does not receive telephone calls, set the machine to FAX-dedicated reception. No special operation is required when receiving faxes.

Reception Method

The methods for receiving faxes on the machine are shown below.

- Auto (Normal)
- Auto (FAX/TEL) (Refer to [5-28.](#))
- Auto (Answering machine) (Refer to [5-30.](#))
- Manual (Refer to [4-4.](#))
- Auto (DRD) (Available for some countries.) (Refer to [5-32.](#))

Checking and Changing the Reception Method

1 Display the screen.

[System Menu/Counter] key > [FAX] > [Reception] > [Reception Mode]

2 Select the reception method.

Select the reception method.

For FAX Automatic Reception, select [**Auto (Normal)**].

Flow of reception

1 Reception Starts

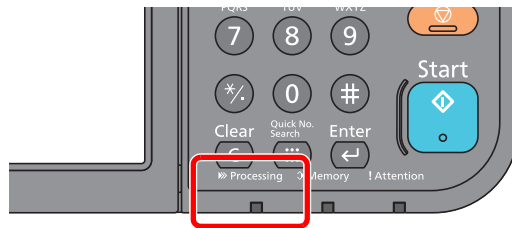

When a fax comes in, the **[Processing]** indicator blinks and reception automatically begins.



NOTE

When a telephone (commercially available product) is connected to the machine, reception starts after the telephone rings.

You can change the number of times the ringing tone rings.

➔ [FAX \(page 8-7\)](#)

Memory Reception

When the machine cannot print a fax due to paper running out or a paper jams, it temporarily stores originals that have been sent in the image memory. When the machine returns to the printable state, printing starts.

The number of pages that can be stored depends on the pages. As a general guideline, about 256 or more A4 size pages at normal resolution can be stored.

During memory reception, FAX Reception Printing Jobs are displayed on Printing Jobs of the Status screen. To print the received originals, supply paper or remove jammed paper.

For the Status screen, refer to the following:

➔ Machine's *Operation Guide*

2 Reception Print

Received faxes are output to the inner tray with the printed side facing down.

Canceling reception (Disconnection of communication)

When you cancel receiving by disconnecting the telephone line during communication, use the following procedure.

1 Select the **[Status/Job Cancel]** key.

2 **Disconnection of communication.**

[FAX] > [Line Off]

When communication is disconnected, reception stops.

Manual Reception

This method allows you to receive faxes by selecting [**Manual RX**] after confirming that the telephone line has connected to the sending system.

NOTE
To use Manual Reception, you need to change the receiving mode to Manual Reception. To change to manual mode, refer to the following:

➔ [Reception \(page 8-8\)](#)

Connecting a telephone set (commercially available product) to this machine enables you to receive originals after talking to the person at the sending system.

➔ [Manual Reception \(page 5-35\)](#)

[Remote Switch Function \(page 5-36\)](#)

Flow of reception

1 The telephone rings.

When there is an incoming call, the telephone connected to the machine makes a ringing tone.

2 Lift the handset.

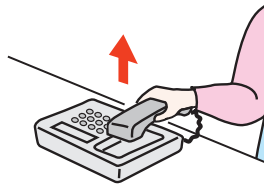

Lift the handset of the telephone.

3 Check if the telephone line has connected to the fax of the sending system.

If the destination is a fax machine, you will hear soft beep sounds. If a person answers, you can talk to that person.

4 [**FAX**] on the Home screen > [**On Hook**] > [**Manual RX**]

Reception will start.

NOTE
When using a telephone set that can send tone signals, use the telephone to start the reception of originals with the remote switch function.

➔ [Remote Switch Function \(page 5-36\)](#)

5 Replace the handset.

When reception starts, return the handset to its original position.

Fax reception functions

The reception method and fax printing method can be set.

What do you want to do?	Reference Page
Print received faxes on both sides of the paper.	Duplex Printing ► page 4-6
Receive a two-page fax on one page.	2 in 1 Print ► page 4-6
Print received faxes together as a batch.	Batch Print ► page 4-6
Print the date and time of reception and other information.	Reception Date/Time ► page 4-6
Restrict the type of paper that can be used.	Media Type for Print Output ► page 4-7
Connection to PBX (Private Branch Exchange). (Europe only)	PBX Setting (Europe only) ► page 2-10
Forward received faxes to another fax machine or a computer.	Forward Settings ► page 5-2
Store received faxes in the machine without printing them.	Sub Address Box Function ► page 5-8
Initiate reception of a fax by controlling the receiving machine.	Polling Communication ► page 5-15
Encrypt an original to send it safely.	Encryption ► page 5-23

Fax reception settings

Duplex Printing

When received multiple pages of data are the same width, they can be printed out on both sides of paper having the same width as the data.

On	Print on both sides.
Off	Do not print on both sides.

For more information about configuring settings, refer to the following:

➔ [Default fax settings \(page 8-2\)](#)

2 in 1 Print

When you receive a multi-page Statement or A5 size original, this function prints 2 pages of the original at a time on one Letter or A4 size sheet of paper. If you specify 2 in 1 reception and duplex printing at the same time, 2 in 1 reception is disabled.

On	Print 2 in 1.
Off	Do not print 2 in 1.

For more information about configuring settings, refer to the following:

➔ [Default fax settings \(page 8-2\)](#)

Batch Print

When a multi-page fax is received, the pages are printed in a batch after all pages are received.

On	Print as a batch after all pages are received.
Off	Print each page as it is received.

For more information about configuring settings, refer to the following:

➔ [Default fax settings \(page 8-2\)](#)

Reception Date/Time

Reception Date/Time function adds the reception date/time, sender information and number of pages on the top of each page when the message is printed out. It is useful for confirming the time of reception if the fax is from a different time zone.



NOTE

When the received data is printed on multiple pages, the reception date/time is printed on the first page only. It is not printed on the pages that follow. When the received fax data is forwarded after retrieving it from memory, the reception date/time is not added to the forwarded data.

On	Print the reception date/time.
Off	Do not print the reception date/time.

For more information about configuring settings, refer to the following:

➔ [Default fax settings \(page 8-2\)](#)

Media Type for Print Output

Specify the paper type to be used for print output of the received fax.

Supported paper types	All Media Types, Plain, Rough, Vellum, Labels, Recycled, Bond, Cardstock, Color, Envelope, Thick, High Quality, Custom 1-8
-----------------------	--

For more information about configuring settings, refer to the following:

➔ [Default fax settings \(page 8-2\)](#)

Setting the cassette for the print output of received faxes

By specifying the media type, faxes can be received on the corresponding cassette.

1 Display the screen.

[System Menu/Counter] key > [Cassette/MP Tray Settings] > [Cassette1-5] or [Multi Purpose Tray]

Select the cassette that you want to use for fax reception.

2 Selecting the paper size.

1 Select [Paper Size] > [Metric] or [Inch].

2 Select the paper size.



IMPORTANT

Specify the paper size as follows for the cassette that you want to use for fax reception.

Inch models: Letter, Legal, Statement

Metric models: A4, B5, A5, Folio

If the cassette has a paper size dial, set the size dial to "Other".

To specify the paper size, refer to the following:

➔ Machine's *Operation Guide*

3 Selecting the paper type.

1 Select [Media Type].

2 Select the paper type.

4 Set the paper type.

Configure paper settings for fax reception. When selecting the paper type, select the same paper type as you selected in step 3.

For more information about configuring settings, refer to the following:

➔ [Default fax settings \(page 8-2\)](#)

5 Using Convenient Fax Functions

This chapter explains the following topics:

Forward Settings	5-2
Type of Forwarding Destination	5-2
Setting Forwarding	5-2
Registering Forwarding Destination	5-2
Changing and Deleting Registration Contents	5-3
Forwarding Time Setting	5-4
File Format Setting	5-4
File Separation	5-4
E-mail Subject Add. Info. Setting	5-5
FTP Encrypted TX Setting	5-5
Print Setting	5-5
File Name Registration	5-6
Settings for Forwarding from Embedded Web Server RX (Forward Settings)	5-7
Sub Address Box Function	5-8
Sub Address Box	5-8
Sub Address Communication	5-8
Registering a Sub Address Box	5-9
Changing/Deleting Sub Address Box	5-10
Printing Originals from a Sub Address Box	5-11
Checking Details	5-12
Deleting Originals after Printing from a Sub Address Box	5-12
Deleting Originals from a Sub Address Box	5-13
Printing a Sub Address Box List	5-13
Sub Address Transmission	5-14
Polling Communication	5-15
Polling Transmission	5-15
Polling Reception	5-17
Printing from a Polling Box	5-19
Checking Details	5-20
Deleting Originals in a Polling Box	5-20
FAX Memory RX Box	5-21
How to print from the FAX Memory RX Box	5-21
How to delete a fax from the FAX Memory RX Box	5-22
Encryption	5-23
Registering an Encryption Key	5-24
Changing and Deleting Registration Contents of Encryption Key	5-25
Using the Encrypted Transmission	5-26
Setting the Encrypted Reception	5-27
Using a Connected Telephone	5-28
FAX/TEL Auto Switch Reception	5-28
FAX/Answering Machine Auto Switch Reception	5-30
DRD Reception (Available for some countries.)	5-32
Manual Send	5-34
Manual Reception	5-35
Remote Switch Function	5-36

Forward Settings

When you have received a fax, you can forward the received image to other fax machines or computers, or set printing.

Type of Forwarding Destination

Only one forwarding destination can be specified. When forwarding is set to **[On]**, all received documents will be forwarded to the specified destination.

You can forward the document to other fax machines or for e-mail transmission or folder (SMB or FTP) transmission.

Setting Forwarding

Use the procedure below to set forwarding.

- 1 Display the screen.**
[System Menu/Counter] key > [FAX] > [Forward Settings] > [Forwarding]
- 2 Configure the function.**
To set Forwarding, select **[On]**.



NOTE

When not using Forwarding, select **[Off]**.

Registering Forwarding Destination

Use the procedure below to register a forwarding destination.

- 1 Display the screen.**
[System Menu/Counter] key > [FAX] > [Forward Settings] > [Forward Destination]
- 2 Configure the function.**
 - 1** Select **[+]**.



Display the add destination screen and follow the procedure below to register the forwarding destination. Only one destination can be registered.

Selecting Forwarding Destination from Address Book

- 1** Select **[Address Book]** or **[Ext. Address Book]**.
- 2** Select the destination (individual) you want to register as a forwarding destination.

Entering Forwarding Destination Directly

- 1 Select [Address Entry (FAX)], [Address Entry (Email)] or [Address Entry (Folder)].
- 2 Enter the address to be registered as a forwarding destination.
If [Address Entry (E-mail)] or [Address Entry (Folder)] is selected for the forwarding destination, enter the address.
➔ Machine's Operation Guide



NOTE

For details on character entry, refer to the following:

- ➔ [Character Entry Method \(page 10-2\)](#)

- 3 Select [End].

Changing and Deleting Registration Contents

Use the procedure below to change or delete registration contents.

- 1 Display the screen.

[System Menu/Counter] key > [FAX] > [Forward Settings] > [Forward Destination]

- 2 Edit or delete the destination.

To edit the destination

- 1 Select [...] and change the destination.

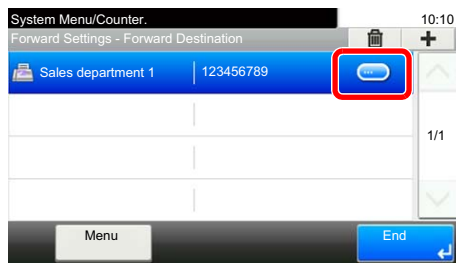

To delete

Select the destination and select [🗑️].

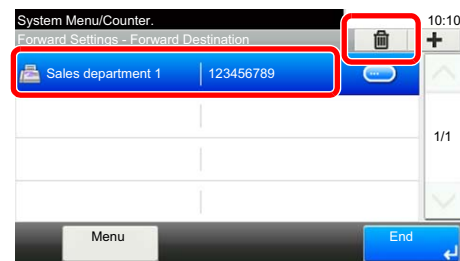

- 3 Select [End].

Forwarding Time Setting

Register the start time and end time between which forwarding is enabled.

1 Display the screen.

[System Menu/Counter] key > [FAX] > [Forward Settings] > [Schedule]

2 Configure the function.

1 Select [All Day] or [Preset Time]. If Preset Time is selected, enter the [Start Time] and [End Time].

2 Enter the start time, and select [Next >].



NOTE

Enter the time on the 24 hours system.

3 Enter the end time, and select [OK].

File Format Setting

If you are sending the file as an E-mail attachment or transferring it to a folder (SMB or FTP), select PDF, TIFF, XPS, or OpenXPS as the file format.

1 Display the screen.

[System Menu/Counter] key > [FAX] > [Forward Settings] > [File Format]

2 Configure the function.

Select [PDF], [TIFF], [XPS] or [OpenXPS].



NOTE

If you have selected [PDF] for file format, PDF Encryption functions are available.
If the optional OCR Scan Activation Kit is installed, you can create a text-searchable PDF.

➔ *Machine's Operation Guide*

File Separation

When sending by e-mail transmission, folder (SMB) transmission, or folder (FTP) transmission, specify whether File Separation is performed.

1 Display the screen.

[System Menu/Counter] key > [FAX] > [Forward Settings] > [File Separation]

2 Configure the function.

Select [Each Page] or [Off].

To create one file per page, select [Each Page].

E-mail Subject Add. Info. Setting

Specify whether any information will be added to the subject of the E-mail. When adding information, you can select either Sender Name or Sender.

1 Display the screen.

[System Menu/Counter] key > [FAX] > [Forward Settings] > [E-mail Subject Add. Info.]

2 Configure the function.

Select [Sender Name], [Sender FAX No.], or [Off].

FTP Encrypted TX Setting

Specify whether to use FTP encryption when you send data.



NOTE

To use FTP encryption, set SSL to [On] in the Secure Protocol settings.

➔ *Machine's Operation Guide*

1 Display the screen.

[System Menu/Counter] key > [FAX] > [Forward Settings] > [FTP Encrypted TX]

2 Configure the function.

Select [On] or [Off].

Print Setting

You can set whether the machine should print received originals when forwarding them.

1 Display the screen.

[System Menu/Counter] key > [FAX] > [Forward Settings] > [Print]

2 Configure the function.

Select [On] or [Off].

File Name Registration

You can set the file name to be created when forwarding. You can append information such as the date/time and the job number or fax number.

1 Display the screen.

[System Menu/Counter] key > [FAX] > [Forward Settings] > [File Name]

2 Configure the function.

1 Enter the file name.



NOTE

For details on character entry, refer to the following:

➔ [Character Entry Method \(page 10-2\)](#)

Please note that when you have not add any additional information, file names become the same, and, therefore, old files are overwritten when received originals are forwarded with folder (SMB) transmission and folder (FTP) transmission.

2 Select [Next >].

3 Set additional information.

If you do not want to add information to the document name, select [None], and set [None] or [FAX No.] for sender name information addition.

To add document information, select [Date and Time], [Job No.], [[Job No.] & [Date and Time]], or [[Date and Time] & [Job No.]], and set [None], [Add No./Addr to Front], or [Add No./Addr to Back] for sender name information addition.

File name sample

Example: doc00352720140826181723.pdf

doc (file name) + 6-digit job number + year/month/day/hour/minute/second +file format (default setting is .pdf)

Settings for Forwarding from Embedded Web Server RX (Forward Settings)

You can use Embedded Web Server RX on a computer connected to the network to specify the forwarding settings on this machine.

For information on the network settings, refer to the followings:

➔ *Machine's Operation Guide*

Accessing Embedded Web Server RX

1 Display Embedded Web Server RX.

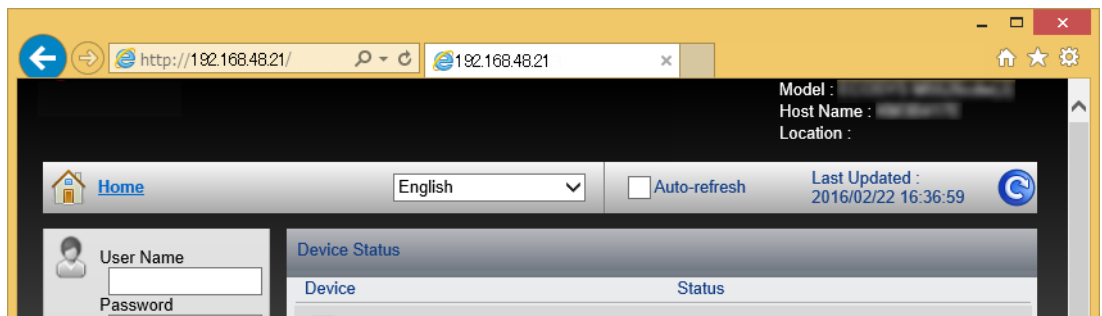

1 Open the web browser.

2 In the Address or Location bar, enter the machine's IP address as the URL, e.g. 192.168.48.21/.

The web page displays basic information about the machine and Embedded Web Server RX as well as the current status of the machine.

2 Select settings in Embedded Web Server RX.

Select a category from the navigation bar on the left to view and set values for that particular category.

If administrator privileges have been enabled on Embedded Web Server RX, remember to enter the correct user name and password when trying to access the relevant screens.

➔ *Embedded Web Server RX User Guide*

Sub Address Box Function

Sub Address Box

A Sub Address Box is a box for storing received originals on the machine to which the FAX System is to be installed. Using sub address reception function, you can store received originals in a personal Sub Address Box.

For the method for using a Sub Address Box, see the next section.

- Registering a Sub Address Box ► page 5-9
- Changing/Deleting Sub Address Box ► page 5-10

For the method for manipulating a received fax stored in a Sub Address Box, see the next section.

- Printing Originals from a Sub Address Box ► page 5-11
- Checking Details ► page 5-12
- Deleting Originals after Printing from a Sub Address Box ► page 5-12
- Deleting Originals from a Sub Address Box ► page 5-13
- Printing a Sub Address Box List ► page 5-13

For the method for transmitting to a Sub Address Box, see the next section.

- Sub Address Transmission ► page 5-14

Sub Address Communication

Sub address communication is communication in which data is sent and received with sub addresses and passwords attached in conformance with the ITU-T (International Telecommunication Union) recommendations. Sub addresses enable communication modes with third-party machines that were previously only possible between our brand machines. These include confidential delivery (sending originals to an original delivery box set up in the receiving system) and polling communication (reception of documents from a source machine that is controlled from the receiving machine). Using sub address communication on this machine also allows advanced communication functions such as storing received originals in Sub Address Boxes.

NOTE

In order to conduct sub address communication, the other party's system also needs to be equipped with sub address communication functions of the same type.

Sub address-based communication can be used together with various kind of functional communication. When registering a sub address and sub address password in the Address Book and One Touch Key, you can omit their entry before transmission. For details, refer to the explanations in the procedure of each communication method and registration method.

Sub Address

With the machine, sub address and sub address passwords are called sub address.

Sub Address

Use the numbers from 0 to 9, ' (space)', and '#' and '*' characters to enter a sub address of up to 20 digits. When the machine receives faxes, a sub address is used to specify the Sub Address Box.

Sub Address Password

Use the numbers from 0 to 9, alphabets, ' (space)', and '#' and '*' characters to enter a sub address password of up to 20 digits. When the machine receives originals, a sub address password is not used.

For the procedure for setting a sub address, refer to the following:

- [Sub Address Transmission \(page 5-14\)](#)

Registering a Sub Address Box

Up to 20 Sub Address Boxes can be registered.

NOTE

If user login administration is enabled, you can only edit destinations in the Address Book by logging in with administrator privileges.

Sub Address Boxes can also be registered in the system menu.

1 Select [Sub Address Box] on the Home screen.

2 Configure the function.

1 [Menu] > [Add]

2 Enter the box name, and select [Next >].

For details on character entry, refer to the following:

➔ [Character Entry Method \(page 10-2\)](#)

3 Enter the sub address, and select [Next >].

NOTE

You can use up to 20 digits including the numbers from 0 to 9, ' (space)', '#' and '*' characters to enter a sub address.

4 Enter the information and then select [OK].

The table below lists the items to be set.

Item	Description
Box No.	Enter the box number. If you enter 00, the smallest number available will be automatically assigned.
Owner*	Set the owner of the box. Select the owner from the user list that appears.
Permission*	Select whether to share the box.
Box Password	User access to the box can be restricted by specifying a password to protect the box. Entering a password is not mandatory. Enter the same password of up to 16 characters in both [Box Password] and [Confirm Password].
Delete after Printed	Automatically delete a document from the box once printing is complete. To delete the document, select [On]. To retain the document, select [Off].

* Displayed when the user login administration is enabled.

3 Check the details you have entered and then select [Save].

A box is created.

Changing/Deleting Sub Address Box



NOTE

Sub Address Boxes can also be changed/deleted in the system menu.

1 Select [Sub Address Box] on the Home screen.

2 Changing/Deleting

Changing

1 [Menu] > [Edit]

2 Select the box that you want to change and change the settings.

The table below lists the items to be set.

Item	Description
Box Name	Set the box name to be displayed on the touch panel.
Box No.	Enter the box number. If you enter 00, the smallest number available will be automatically assigned.
Sub Address	Enter the sub address.
Owner*	Set the owner of the box. Select the owner from the user list that appears.
Permission*	Select whether to share the box.
Box Password	User access to the box can be restricted by specifying a password to protect the box. Entering a password is not mandatory. Enter the same password of up to 16 characters in both [Box Password] and [Confirm Password].
Delete after Printed	Automatically delete a document from the box once printing is complete. To delete the document, select [On]. To retain the document, select [Off].

* Displayed when the user login administration is enabled.

Deleting

1 [Menu] > [Delete]

2 Select the box that you want to delete.

3 Select [Yes].
The box is deleted.

Printing Originals from a Sub Address Box

To print the originals that have been sent to a Sub Address Box, use the following operation.

1 Select [Sub Address Box] on the Home screen.

2 Selecting the Originals.

- 1 Select the box containing the document you want to print.



NOTE

When the password is set to a Sub Address Box, you need to enter the password in the following situations:

If user login is disabled

If user login is enabled but the Sub Address Box has been selected by another user when you login with user privileges

- 2 Select the document you want to print.

- 3 Select [**Print**].

3 Print

- 1 It is possible to change the print settings.

Item	Description
Delete afterPrint	The original is deleted after printing. ➔ Deleting Originals after Printing from a Sub Address Box (page 5-12)
File Name Entry	Adds a file name.
Job Finish Notice	Sends E-mail notice when a job is complete.
Priority Override	Suspends the current job and gives a new job top priority.
Quiet Mode	Lower print and scan speed for quiet processing.

- 2 Press the [**Start**] key. Printing starts.

Checking Details

You can use the procedure below to check the details of documents forwarded to a Sub Address Box.

- 1 Select [Sub Address Box] on the Home screen.**
- 2 Selecting the Originals.**
 - 1** Select the box containing the document you want to check.
 - 2** Select [...] for the document whose details you want to check. The details of the selected document are displayed.

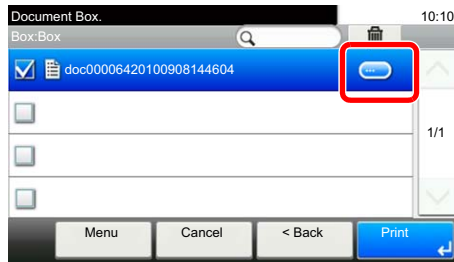

Deleting Originals after Printing from a Sub Address Box

To automatically delete the originals printed from the Sub Address Box, use the following operation.

- 1 Select [Sub Address Box] on the Home screen.**
- 2 Selecting the Originals.**
 - 1** Select the box containing the document you want to print.
 - 2** Select the document you want to print.
 - 3** Select [**Print**].
- 3 Configure the function.**

[Delete afterPrint] > [On]
- 4 Print.**

Press the [**Start**] key.
The original is deleted after printing.

Deleting Originals from a Sub Address Box

Use the procedure below to delete an original that you have forwarded to a Sub Address Box.

- 1 Select [Sub Address Box] on the Home screen.**
- 2 Deleting**
 - 1 Select the box containing the document you want to delete.
 - 2 Select the document you want to delete, and select [].

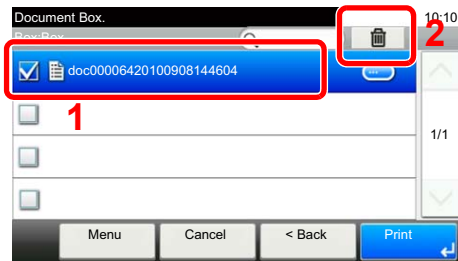

- 3 Select [Yes].**
The original is deleted.

Printing a Sub Address Box List

You can print the Sub Address Box list in which the list of Box No.'s and Box names of the registered Sub Address Boxes are described. When there are originals in the Sub Address Boxes, the number of pages is displayed.

 **NOTE**
The list can be printed when user login has been enabled and the machine is logged in with administrator privileges.

- 1 Display the screen.**
[System Menu/Counter] key > [Document Box] > [Sub Address Box]
- 2 Print**
[Print List] > [Yes]
The list is printed.

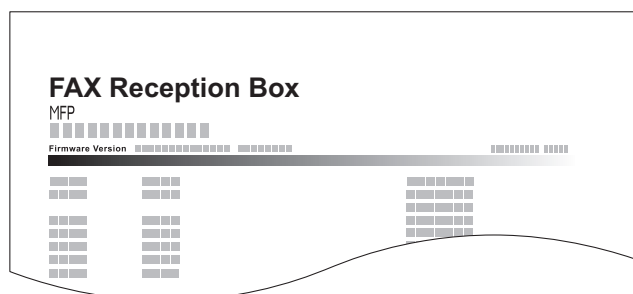

Sub Address Transmission

To specify a Sub Address Box when sending a fax, follow the steps below.

NOTE

To use sub address transmission, check that a sub address and password have been set in the receiving system in advance.

Encrypted transmission cannot be used in sub address transmission.

For the setting method when the machine receives originals, refer to the following:

➔ [Sub Address Box Function \(page 5-8\)](#)

1 Select [FAX] on the Home screen.

2 Place the originals.

3 Specifying destination.

- 1 Select [Add Dest.] and enter the fax number of the other party.

NOTE

When a sub address has been registered to the destination of the Address Book, you can use the destination. When a sub address-registered destination in the Address Book is used for a One Touch Key, you can also use the One Touch Key.

4 Configure the function.

- 1 [Sub Address] > [Sub Address]
- 2 Enter the sub address using the numeric keys, and then enter the [OK] key.
You can use up to 20 digits including the numbers from 0 to 9, ' (space)', '#' and '*' characters to enter a sub address.
- 3 Select [Password].
- 4 Enter the sub address password using the numeric keys, and then enter the [OK] key.
You can use up to 20 digits including the numbers from 0 to 9, ' (space)', '#' and '*' characters to enter a sub address password.
- 5 [OK] > [OK]

5 Send Start.

Check the destination and press the [Start] key.

NOTE

When *On* is selected in *Dest. Check before Send*, a destination confirmation screen is displayed when you press the [Start] key.

➔ [Confirmation Screen of Destinations \(page 7-10\)](#)

Polling Communication

Polling communication is a communication mode in which the transmission of originals on the sending machine is controlled by the receiving machine. This allows the receiving machine to tailor the reception of originals to its own circumstances. This machine supports both polling transmission and polling reception.



IMPORTANT

Because the receiving machine dials the sending machine in polling communication, call charges are normally borne by the recipient.

Polling Transmission

Originals to be used in polling transmissions should be stored in a Polling box. When a polling request is received from the destination, the stored originals are sent automatically.

Once originals intended for polling transmission have been sent to the destination, they are automatically deleted. However, if you set Delete Transmitted File to **[Off]**, the originals are stored in the Polling box until you delete them. You can use polling transmission with the same originals as many times as you wish.

➔ [Deleting Originals After Polling Transmission \(page 5-15\)](#)



NOTE

You can store up to 10 originals for polling transmission.

You can also add to or overwrite originals up until a polling request arrives from the destination.

➔ [Overwrite Setting \(page 5-15\)](#)

Deleting Originals After Polling Transmission

Originals intended for polling transmission are automatically deleted after they have been sent to the destination. To allow polling transmission of the same original to multiple destinations, set this option to **[Off]**.

1 Display the screen.

[System Menu/Counter] key > [Document Box] > [Polling Box]

2 Configure the function.

[Delete Transmitted File] > [On] or [Off]

Overwrite Setting

To allow overwriting, set this option to **[Permit]**.

Use the procedure below to overwrite the existing document if the same name is added to the new file.

If this option is set to **[Prohibit]**, the existing document will not be overwritten if the same file name is set.

1 Display the screen.

[System Menu/Counter] key > [Document Box] > [Polling Box]

2 Configure the function.

[Overwrite Setting] > [Permit] or [Prohibit]

Using Polling Transmission

- 1** Select [Polling Box] on the Home screen.
- 2** Place the originals.
- 3** Display the screen.
Select [Store File].
- 4** Select the type of originals, scanning density, etc., as necessary.

The table below lists the items to be set.

Function		Description
Duplex		Select the type and binding of originals.
Scan Resolution		Set the resolution at which to scan originals.
Density		Adjust density.
File Name Entry		Adds a file name.
Quiet Mode		Lower print and scan speed for quiet processing.
Functions	Original Size	Select the size of originals to be scanned.
	Orig. Orientation	Select the orientation of the original document top edge to scan correct direction.
	Original Image	Select original image type.
	Skip Blank Page	When there are blank pages in a scanned document, this function skips the blank pages and prints only pages that are not blank.
	Continuous Scan	Scan a large number of originals separately and then produce as one job.
	Job Finish Notice	Sends a notice by an e-mail when a transmission is complete.

For each of the functions, refer to the following:

➔ [Sending Faxes \(page 3-1\)](#)

Machine's *Operation Guide*

5 Start storing.

Press the [Start] key. The originals are scanned and stored in the Polling box.

Cancelling Polling Transmissions

To cancel a polling transmission, delete the polling transmission original saved in the polling box. For information on how to delete the saved original, refer to the following:

➔ [Deleting Originals in a Polling Box \(page 5-20\)](#)

Polling Reception

This function automatically triggers transmission of originals stored on the sending machine when the receiving machine dials the sending machine's number.

NOTE

Multiple contacts cannot be specified for polling reception. If you specified a destination for which encrypted communication is registered, encrypted communication is disabled for polling reception.

To use polling reception, you must first ensure that the sending machine is set up for polling transmission.

Using sub addresses at the same time allows the communication modes described below.

Sub Address Bulletin Board Reception

If the recipient's machine has a sub address bulletin board function, you can use sub addresses to communicate with that machine even if it is a third-party machine. (On this machine, the sub address and sub address password.)

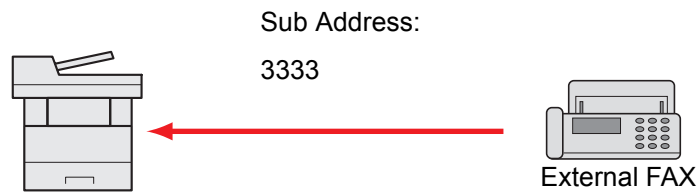

IMPORTANT

The recipient's machine must also be equipped with a sub address bulletin board function. Some fax machines cannot store originals and some do not support polling transmission. Check both the sending and receiving machines beforehand to ensure that they each have the required functionality.

Ask the recipient for the sub address and password that are registered in the recipient's machine.

NOTE

For more information on sub addresses, refer to the following:

➔ [Sub Address Communication \(page 5-8\)](#)

For information on how to receive files using sub address bulletin board communication, refer to the following:

➔ [Using Polling Reception with Sub Addresses \(page 5-18\)](#)

Using Polling Reception



NOTE

When the other party is using sub addresses, refer to Using Polling Reception with Sub Addresses below.

1 Select **[FAX]** on the Home screen.

2 Turn on polling reception.

[Functions] > [FAX Polling RX] > [On]

3 Specifying destination.

➔ [Methods For Entering the Destination \(page 3-7\)](#)

4 Press the **[Start]** key.

The operations for reception begin.



NOTE

When *On* is selected in *Dest. Check before Send*, a destination confirmation screen is displayed when you press the **[Start]** key.

➔ [Confirmation Screen of Destinations \(page 7-10\)](#)

Using Polling Reception with Sub Addresses

For polling reception, enter the sub address (on this machine, sub address and sub address password) set at the sending machine. This communication is still possible when the other party is using a third-party machine provided it is equipped with the same type of sub address communication function.



IMPORTANT

Check the sub address set by the sender beforehand.

1 Select **[FAX]** on the Home screen.

2 Turn on polling reception.

To turn on polling reception, refer to the following:

➔ [Polling Reception \(page 5-17\)](#)

3 Select the destination, and entering the sub address.

For the procedure for setting a sub address, refer to the following:

➔ [Sub Address Transmission \(page 5-14\)](#)

For the procedure for selecting a destination, refer to the following:

➔ [Methods For Entering the Destination \(page 3-7\)](#)



NOTE

You can select destinations using a combination of numeric keys input, One Touch Key selection and selection from the Address Book containing registered sub addresses.

4 Press the [Start] key.

The operations for reception begin.



NOTE

When *On* is selected in *Dest. Check before Send*, a destination confirmation screen is displayed when you press the [Start] key.

➔ [Confirmation Screen of Destinations \(page 7-10\)](#)

Printing from a Polling Box

Use this procedure to print an original stored in a Polling box.

1 Select [Polling Box] on the Home screen.

2 Select the original.

1 Select the document you want to print.

2 [Menu] > [Print]

3 Print

1 It is possible to change the print settings.

Item	Description
File Name Entry	Adds a file name.
Job Finish Notice	Sends E-mail notice when a job is complete.
Priority Override	Suspends the current job and gives a new job top priority.
Quiet Mode	Lower print and scan speed for quiet processing.

For each of the functions, refer to the following:

➔ Machine's *Operation Guide*

2 Press the [Start] key.
Printing starts.

Checking Details

Use this procedure to check the details of an original stored in a Polling box.

- 1** Select **[Polling Box]** on the Home screen.
- 2** Select the original.
 - 1** Select the document you want to check.
 - 2** Select [...].
The details of the selected document are displayed.

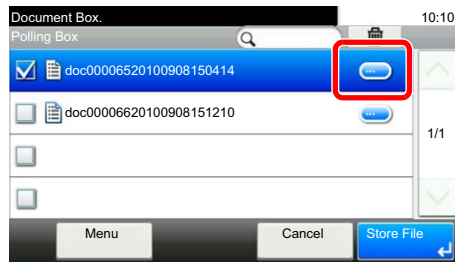

Deleting Originals in a Polling Box

Use this procedure to delete an original stored in a Polling box.



NOTE

If Delete Transmitted File is set to **[On]**, originals are automatically deleted following polling transmitted.

➔ [Deleting Originals After Polling Transmission \(page 5-15\)](#)

- 1** Select **[Polling Box]** on the Home screen.
- 2** To delete
 - 1** Select the document you want to delete and select **[🗑️]**.

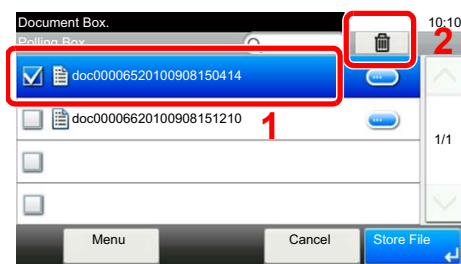

- 2** Select **[Yes]**.
The original is deleted.

FAX Memory RX Box

You can receive faxes to the FAX Memory RX Box, check the contents, and print only the faxes that you need.

IMPORTANT
Check the data stored in the FAX Memory RX Box, and print or delete the data as needed. If the box becomes full, "Full" appears in the upper right side of the screen and faxes received after that will be printed.

NOTE
To use the FAX Memory RX Box, set "FAX Memory RX" to [On].
For the procedure for setting, refer to the following.
→ [FAX Memory RX Box \(page 8-6\)](#)

How to print from the FAX Memory RX Box

Use the following procedure to print a fax received in the FAX Memory RX Box.

1 Select [FAX Memory RX Box] on the Home screen.

2 Select the received data.

The file is selected, a checkmark will be placed.

NOTE

- To unselect, select the checkbox to remove the checkmark.
- To show thumbnails of fax images, select [Thumbnail].
- To show a fax image list, select [Image].
- To show detailed information on the received faxes, select [Detail].

3 [Preview] > Check the contents of a received fax.

The preview screen are shown below.

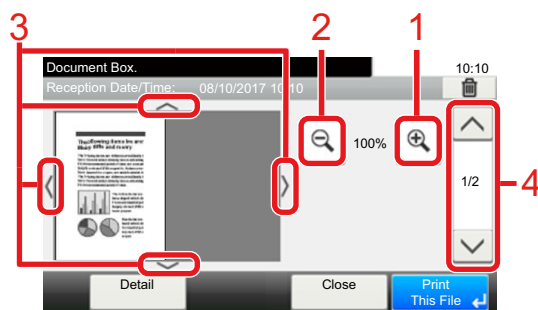

- 1 Zoom in
- 2 Zoom out
- 3 When you have zoomed in, you can use these keys to move the displayed area.
- 4 In multiple-page documents, you can use these buttons to change pages.

4 Select [Print This File].

Printing starts.



NOTE

If you will not use preview, select the received fax you want to print > **[Print]**.

How to delete a fax from the FAX Memory RX Box

Use the following procedure to delete an unneeded fax from the FAX Memory RX Box.

1 Select [FAX Memory RX Box] on the Home screen.

2 Select the received data.

The file is selected, a checkmark will be placed.



NOTE

- To unselect, select the checkbox to remove the checkmark.
- To show thumbnails of fax images, select **[☰]**.
- To show a fax image list, select **[☰]**.
- To show detailed information on the received faxes, select **[Detail]**.

3 [] > Check the contents of a received fax.

The preview screen is displayed.

4 Delete fax.

1 Select **[🗑️]**.

2 Select **[Yes]**.

The fax will be deleted.



NOTE

If you will not use preview, select the received fax you want to delete > **[Delete]** > **[Yes]**.

Encryption

This method allows you to communicate with originals encrypted by the sending system. Therefore, even when a third party tries to view the originals in the middle of communication by some means, the third party is prevented from knowing the actual contents of the originals. The originals received are reverted to the originals as they were before transmission (decrypted) by the receiving system, and printed. This is an extremely effective communication method for sending confidential documents that are not to be opened by a third party.

✓ IMPORTANT

In order to use encryption communication, the fax of the other party needs to be an our-brand system with the same type of encryption functions.

In encryption communication, in order to encrypt and decrypt originals, the sending and receiving systems must use the same 16-digit encryption key. When the encryption key differs between the sending system and the receiving system, the encryption cannot be conducted. Therefore, the sending system and the receiving system need to have the same encryption key and 2-digit key No. registered in advance.

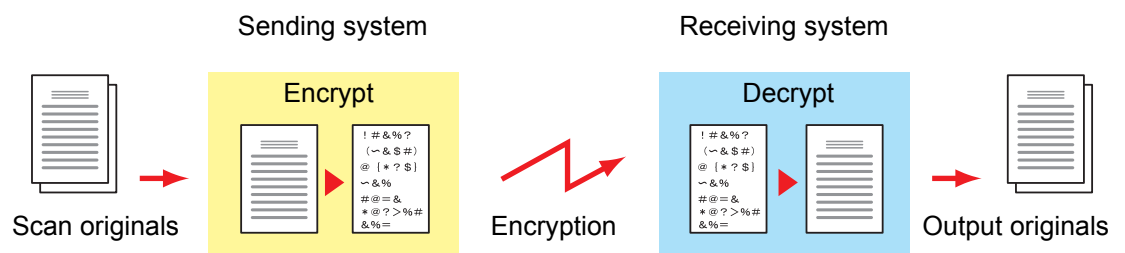

Description of settings at sending and receiving systems

Settings	Sending system	Receiving system	Reference page
Encryption Key No.	(A) 2 digits	(B) 2 digits	5-24
Encryption Key	(C) 16 digits	(C) 16 digits	5-24
Key No. of Address Book (or when the number is directly dialed)	(A) 2 digits	—	5-26
Receiving system encryption box number*	(D) 4 digits	—	5-26
Encryption Box No.*	—	(D) 4 digits	—
Key No. in reception setting	—	(B) 2 digits	5-27

* When the machine receives originals, the Encryption Box is not used.

📌 NOTE

Set the same characters for the numbers indicated by the same letter in parentheses. For example, the same characters should be used as the encryption key (C) in both the sending and receiving systems.

Registering an Encryption Key

An encryption key is required when registering the Address Book used for encryption communication (the other party is directly entered using the numeric keys) in the sending system and when setting encryption in the receiving system.

For the creation of the encryption key, numbers from 0 to 9 and letters from A to F are arranged to form 16 numbers and/or letters arbitrarily. The created encryption key is registered with a 2-digit key No. (01 to 20).



NOTE

Up to 20 encryption keys can be registered.

1 Display the screen.

[System Menu/Counter] key > [FAX] > [TX/RX Common] > [Encryption Key Registration]

2 Configure the function.

- 1 Select [...] for the unregistered encryption key.



- 2 Enter the 16-digit encryption key.



NOTE

Use numbers (0 to 9) and alphabetical letters (A to F) to register the encryption key.

- 3 Select [OK].
- 4 To register other encryption keys, repeat Steps 2-1 to 2-3.

3 Finish registration.

Select [End].

Changing and Deleting Registration Contents of Encryption Key

1 Display the screen.

[System Menu/Counter] key > [FAX] > [TX/RX Common] > [Encryption Key Registration]

2 Change/Delete

Changing

1 Select [...] for the encryption key you want to change.



2 Enter the new encryption key.

3 [OK] > [Yes]

Deleting

1 Select the encryption key you want to delete, and select [🗑️].

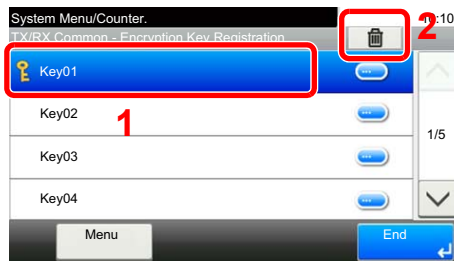

2 Select [Yes].
This deletes the encryption key.

3 Finish changing/deleting.

Select [End].

Using the Encrypted Transmission

When sending originals by encrypted transmission, use the Address Book registered for encryption or set encrypted transmission when dialing directly using the numeric keys.



NOTE

Encrypted transmission can be also used in broadcast transmission. With encryption communication, you cannot conduct sub address transmission.

1 Register the encryption key ahead of time.

Register the encryption key that you decided upon with the recipient.

For the procedure for registering an encryption key, refer to the following:

➔ [Registering an Encryption Key \(page 5-24\)](#)

2 Select [FAX] on the Home screen.

3 Place the originals.

4 Specifying destination.

1 Select [Add Dest.] and enter the fax number of the other party.



NOTE

When encrypted transmission has been set to a destination in the Address Book or One Touch Key, you can use the destination.

5 Turn on encrypted transmission.

1 [Detail Settings] > [Encrypted Transmission] > [Encryption] > [On] > [Encryption Key No.]

2 Select the encryption key number that you used to register the encryption key that you decided upon with the recipient.

For the procedure for registering an encryption key, refer to the following:

➔ [Registering an Encryption Key \(page 5-24\)](#)

6 Select the encryption box.

If you need to select an encryption box, set the box.

1 [Encryption Box] > [On] > [Encryption Box No.]

2 Enter the box number (0000 to 9999) with the numeric keys.

3 Select [OK].

7 Finish the encrypted transmission settings.

[OK] > [OK] > [OK]

8 Send Start

Press the [Start] key.

The transmission will start.



NOTE

When *On* is selected in *Dest. Check before Send*, a destination confirmation screen is displayed when you press the **[Start]** key.

➔ [Confirmation Screen of Destinations \(page 7-10\)](#)

Setting the Encrypted Reception

To conduct encryption communication operating the receiving system, follow the steps below.

1 Register the encryption key ahead of time.

Register the encryption key that you decided upon with the sender.

For the procedure for registering an encryption key, refer to the following:

➔ [Registering an Encryption Key \(page 5-24\)](#)

2 Display the screen.

[System Menu/Counter] key > **[FAX]** > **[Reception]**

3 Turn on encrypted reception.

1 **[Encrypted Reception]** > **[On]**

2 Select the encryption key number that you used to register the encryption key that you decided upon with the sender.

3 Select **[OK]**.

The machine receives the encrypted originals from the sender of the specified encryption key.

Using a Connected Telephone

It is possible to connect a telephone (a commercially available item) to this machine and use various functions.

FAX/TEL Auto Switch Reception

This reception method is convenient when using both telephone and fax on a single telephone line. When fax originals have been sent, the machine automatically receives them, and when the other party is calling from a telephone, the machine makes a ringing tone urging the user to respond.

 **IMPORTANT**

In order to use FAX/TEL Auto Switch Reception, it is necessary to connect a telephone set (commercially available product) to the machine.

After the telephone has made a ringing tone for the preset number of times, the other party is required to pay phone line charges even if the receiving system does not respond.

Flow of reception

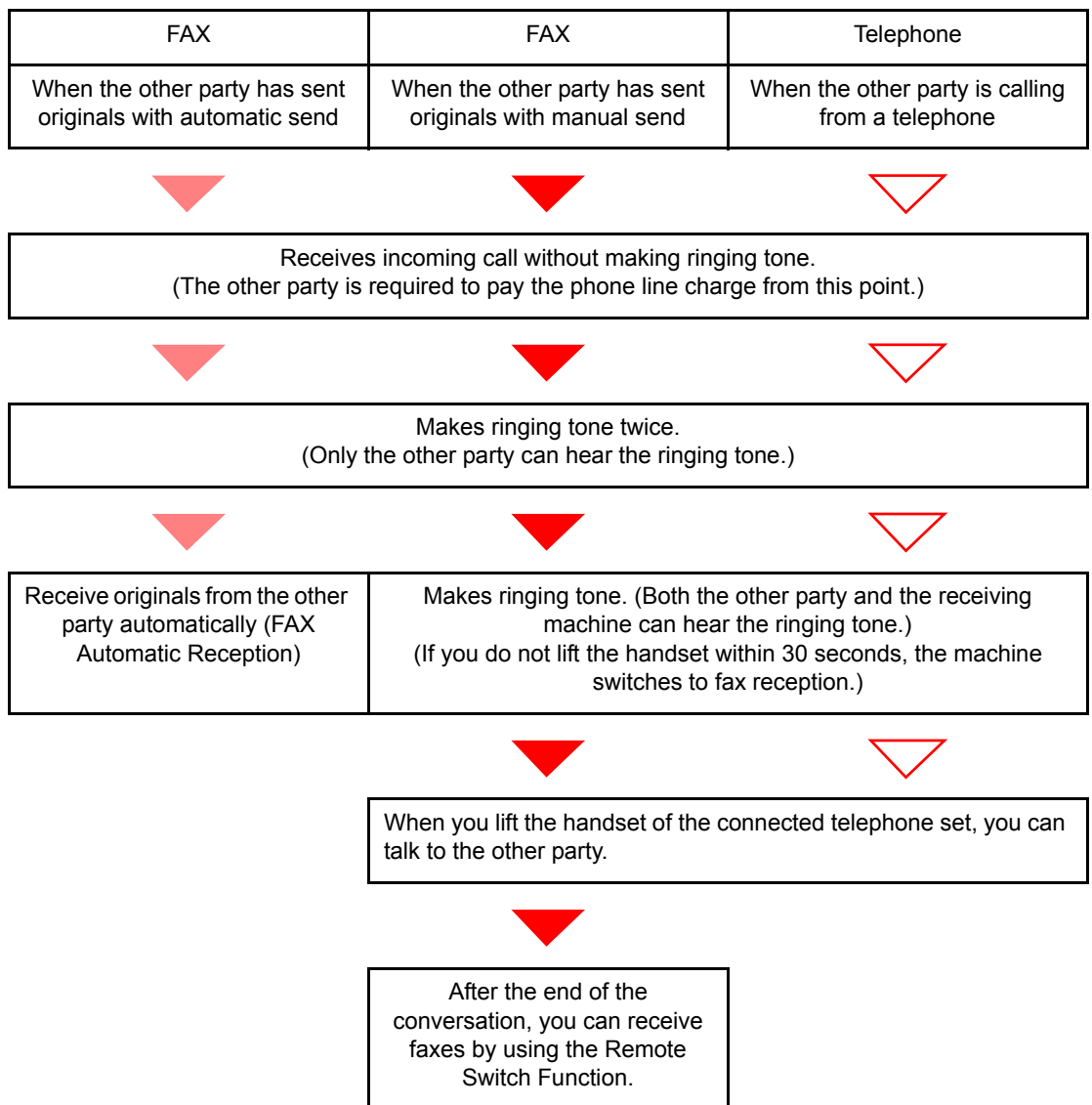

 **NOTE**

At the end of the conversation, you can also receive faxes by using the Remote Switch Function.

➔ [Remote Switch Function \(page 5-36\)](#)

Preparation:

Select [**Auto (FAX/TEL)**].

➔ [FAX \(page 8-7\)](#)

1 The telephone rings.



The connected telephone set makes a ringing tone. Note that if [**0**] (zero) is set as the number of rings (for FAX/TEL Auto Switch), the connected telephone does not ring.



NOTE

You can change the number of times the ringing tone rings.

➔ [Rings\(FAX/TEL\) \(page 8-9\)](#)

2 Answer the call.

When the call is from a telephone

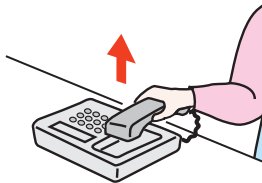

- 1 The machine makes a ringing tone urging the user to respond. Lift the handset of the telephone within 30 seconds.



NOTE

If you do not lift the handset within 30 seconds, the machine switches to fax reception.

- 2 Talk to the other party.



NOTE

At the end of the conversation, you can also receive faxes by using the Remote Switch Function.

➔ [Remote Switch Function \(page 5-36\)](#)

When the call is from a fax

The machine starts receiving fax originals.

FAX/Answering Machine Auto Switch Reception

This method is convenient when using both the answering machine and fax. When fax originals have been sent, the machine receives them automatically, and when the call is from a telephone, the machine follows the functions of the connected answering machine. Therefore, when the user is absent, the other party can leave a message on the answering machine.

 **IMPORTANT**

When using FAX/Answering Machine Auto Switch Reception function, if a silence continues for at least 30 seconds before one minute passes after the machine has received a call from the other party, the machine's silence detection function comes into operation and the machine switches to fax reception.

 **NOTE**

In order to use FAX/Answering Machine Auto Switch Reception, it is necessary to connect an answering machine-equipped telephone set (commercially available product) to the machine.

For details, such as responding to messages, refer to the Operation Guide of each answering machine.

Set the number of rings to be made by the machine more than the number of rings to be made by the answering machine.

➔ [Rings \(Answering Machine\) \(page 8-9\)](#)

Flow of reception

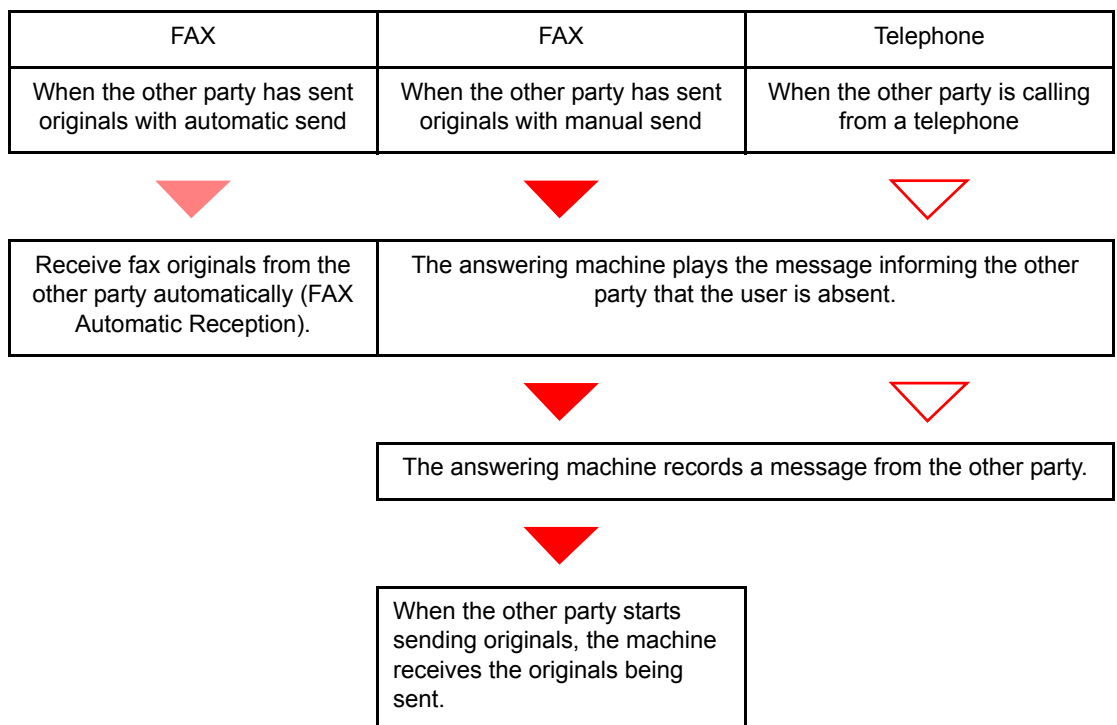

Preparation:

Select **[Auto (TAD)]**.

➔ [FAX \(page 8-7\)](#)

1 The telephone rings.



The connected telephone set makes ringing tone the set number of times.



NOTE

If you lift the handset while the telephone set is still making the ringing tone, the machine enters a status the same as manual reception.

➔ [Manual Reception \(page 5-35\)](#)

2 The answering machine responds.

When the call is from a telephone, but the user is absent

The answering machine plays a response message, and starts recording the other party's message.



NOTE

When silence continues for at least 30 seconds during recording, the machine switches to fax reception.

When the call is from a fax

The machine starts receiving fax originals.

DRD Reception (Available for some countries.)

This reception mode utilizes the Distinctive Ring Pattern service available through some telephone companies. With this service, you can use two or more fax numbers on a single telephone line. Thus, you can use this fax and a telephone on the same line, and you can still designate a different fax number for each of them. As each number is given a different ring pattern, the machine is able to differentiate between incoming calls. If one of these numbers is designated for the machine, and a desired ring pattern is designated for that number in advance, fax reception will be initiated automatically whenever the machine detects the ring pattern distinctive to the fax.



NOTE

Using DRD Reception to receive a telephone call is only possible if a separately purchased telephone is connected to the machine. DRD reception is only possible if you subscribe to the Distinctive Ring Pattern service provided by your telephone company. Contact your telephone company for further information on the Distinctive Ring Pattern service available.

Flow of reception

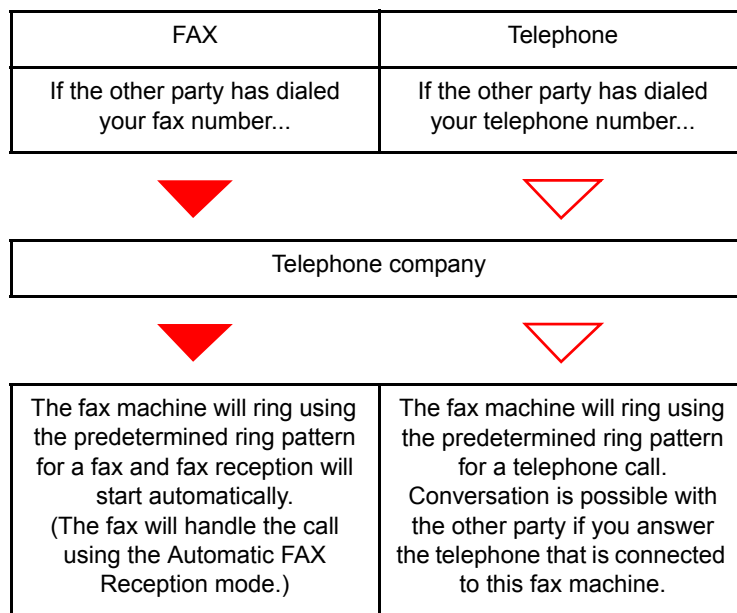

Preparation:

Select **[Auto (DRD)]**.

➔ [FAX \(page 8-7\)](#)

1 The telephone rings.



When a call comes in, the telephone will ring.



NOTE

If you lift the handset while the telephone is still ringing, the machine will deal with the call in the same manner as standard Manual FAX Reception.

➔ [Manual Reception \(page 5-35\)](#)

2 Answer the call.

The machine will then ring using the predetermined ring pattern.

When the call is from a telephone

Lift the handset and speak with the other party. When the conversation is over, fax reception can be initiated manually.

When the call is from a fax

Once the ringing tone stops, fax reception will start automatically.

Manual Send

When you want to talk to the person at the receiving system or the receiving system needs to switch to fax, use this method to send originals.

1 Place the originals.

2 Dial the destination.

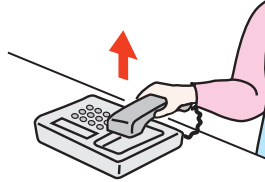

Lift the handset, and dial the number of the receiving system.

3 Check if the telephone line has connected to the fax of the receiving system.

If the destination is a fax machine, you will hear a long high beep sound. If a person answers, you can talk to that person.

4 [FAX] on the Home screen > [On Hook]

5 Press the [Start] key.

Transmission begins.

6 Replace the handset.

When sending starts, return the handset to its original position.

Manual Reception

Reception is possible after confirming that the telephone line has connected to the sending party.



NOTE

FAX Automatic Reception has been preset for the receiving mode of this machine. To use Manual Reception, you need to change the receiving mode to Manual Reception. To change to manual mode, refer to the following:

➔ [Reception Mode \(page 8-9\)](#)

1 The telephone rings.

When there is an incoming call, the telephone connected to the machine makes a ringing tone.

2 Lift the handset.

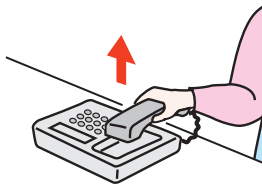

Lift the handset of the telephone.

3 Check if the telephone line has connected to the fax of the sending system.

If the destination is a fax machine, you will hear soft beep sounds. If a person answers, you can talk to that person.

4 [FAX] on the Home screen > [On Hook] > [Manual RX]

Reception will start.



NOTE

When using a telephone set that can send tone signals, use the telephone to start the reception of originals with the remote switch function.

➔ [Remote Switch Function \(page 5-36\)](#)

5 Replace the handset.

When reception starts, return the handset to its original position.

Remote Switch Function

You can start fax reception by operation from the connected telephone set. This function is convenient for using this machine and a telephone set (commercially available product) in combination installed at places distant from each other.



NOTE

In order to use remote switch, it is necessary to connect the tone signal-sending telephone set (commercially available product) to the machine. However, even if it is a tone signal-sending telephone set, this function may not be used satisfactorily depending on the type of telephone set. For details, contact our agent or the store where you purchased this machine.

The remote switch dial is set to 55 at the factory.

The remote switch dial number can be changed.

➔ [Remote SW Dial \(page 8-9\)](#)

Using the Remote Switch Dial

To start fax reception by operation from the connected telephone set, use the following operation.

1 The connected telephone set makes a ringing tone.

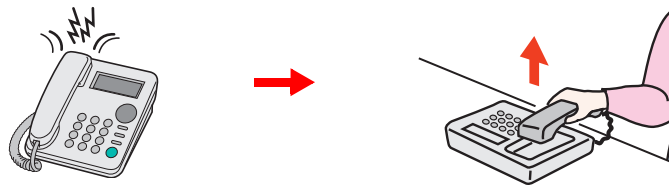

Lift the handset of the telephone.



NOTE

You can change the number of times the ringing tone rings.

➔ [FAX \(page 8-7\)](#)

2 Press the remote switch dial number (2 digits).

When you hear the fax tone from the handset, enter the two-digit remote switch dial number using the dial button on the telephone set. The telephone line switches to the machine, and reception starts.

6 Sending Faxes from PC

This chapter explains the following topics:

Flow of Network FAX Sending	6-2
Flow of Network FAX Receiving	6-2
Setup	6-3
Installing the FAX Driver	6-3
Uninstalling the FAX Driver	6-6
Basic Transmission	6-7
Configuring the Driver Default Settings	6-10
Default Settings Dialog Box	6-11
Changing Transmit Settings	6-14
Using Cover Pages	6-19
Cover Page Registration (Default Settings)	6-24
Transmission Control	6-29

The Network FAX function enables any PC, which is networked to the machine, to perform sending and receiving of faxes. Its primary features include the following.

- PC-prepared document can be sent and received by fax without being printed out.
- An Address Book (in the machine/PC) can be used to specify a desired destination.
- Addition of a cover page.
- Transmission and printing can be done simultaneously.
- E-mail reporting of the transmission result.
- Sub address transmission is available.
- Operation is as simple as printing.

Flow of Network FAX Sending

Network FAX sending is performed in the following sequence.

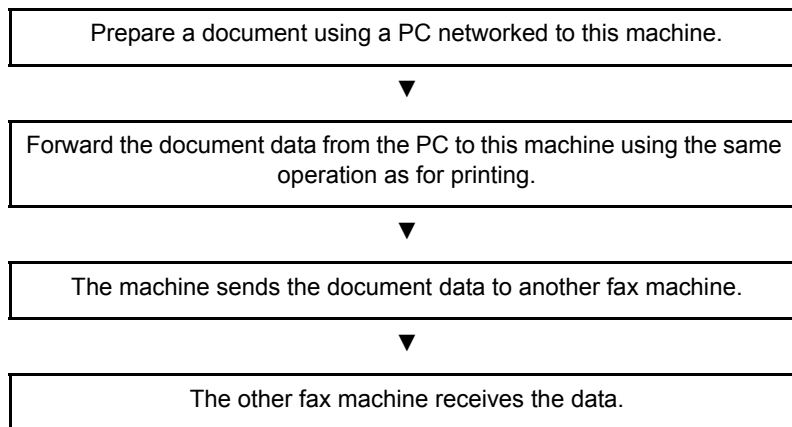

Flow of Network FAX Receiving

Network FAX receiving is performed in the following sequence.

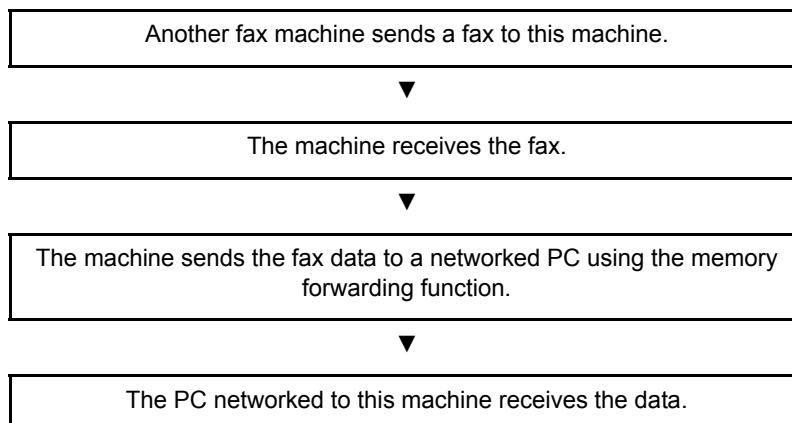

NOTE

The memory forwarding function allows not only reception by the networked PC, but also forwarding of the received fax by e-mail or forwarding to another fax machine.

Setup

The following preparation is needed before using Network FAX.

Connection to a PC

Connect the machine and PC to the network using a network cable.

➔ *Machine's Operation guide*

Machine Registration

Using the memory transmission function, select the recipient PC or file format.



NOTE

Use the memory transmission function to forward the received fax to the PC or forward it as an e-mail attachment.

➔ [Forward Settings \(page 5-2\)](#)

Installing the FAX Driver

The procedure for installing the FAX Driver is explained below. (The screens in Windows 8.1 are shown.)

1 Insert the Product Library disc.

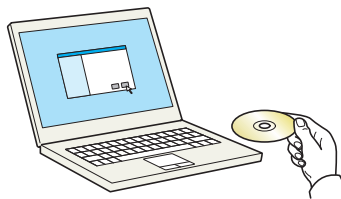

NOTE

Installation on Windows must be done by a user logged on with administrator privileges.

If the "Welcome to the Found New Hardware Wizard" dialog box displays, select [**Cancel**].

If the autorun screen is displayed, click [**Run Setup.exe**].

If the user account management window appears, click [**Yes**].

2 Display the screen.

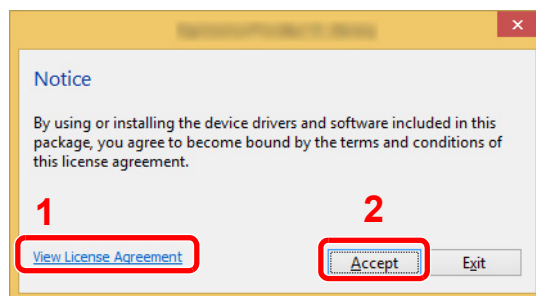

1 Click [**View License Agreement**] and read the License Agreement.

2 Click [**Accept**].

3 Select [**Custom Install**].

4 Install the software.

1 Select the device to be installed.

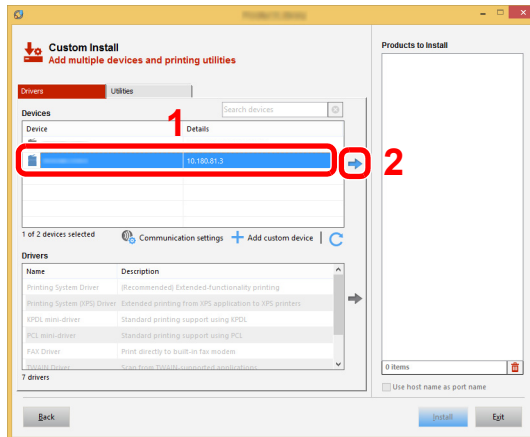

NOTE

- The machine cannot be detected unless it is on. If the computer fails to detect the machine, verify that it is connected to the computer via a network and that it is turned on and click  (Refresh).
- If the desired device does not appear, select **[Add custom device]** to directly select the device.

2 Select [FAX Driver].

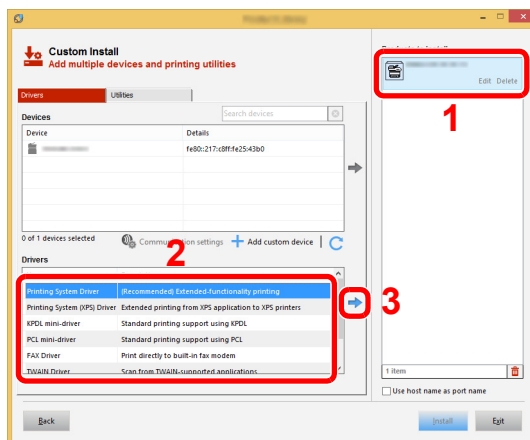

3 Click [Install].

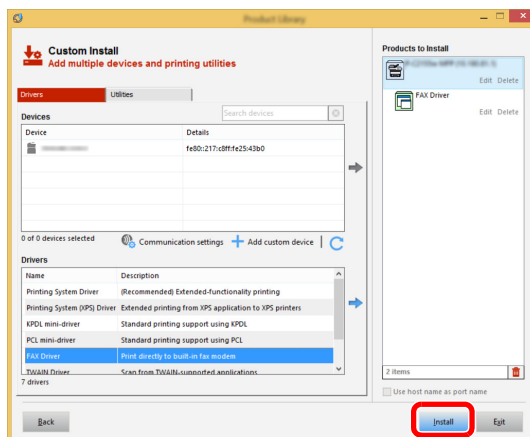

5 Finish the installation.

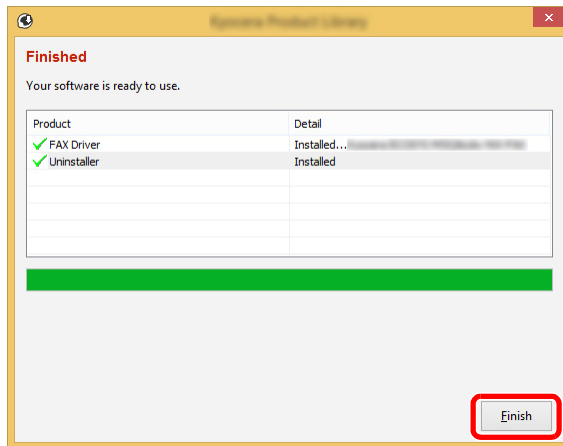

If a system restart message appears, restart the computer by following the screen prompts. This completes the FAX driver installation procedure.

Uninstalling the FAX Driver



NOTE

Uninstallation on Windows must be done by a user logged on with administrator privileges.

1 Display the screen.

Click **[Search]** in charms, and enter "Uninstall Product Library" in the search box. Select **[Uninstall Product Library]** in the search list.



NOTE

In Windows 7, click **[Start]** button on the Windows and then select **[All Programs]**, **[(name of offer company)]**, and **[Uninstall Product Library]** to display the Uninstall Wizard.

2 Uninstall the software.

Place a check in the check box of the driver to be deleted and click **[Uninstall]**.

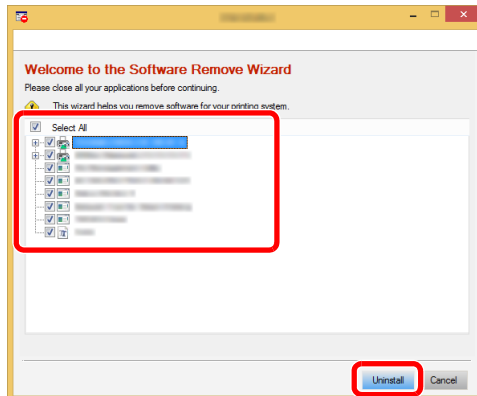

3 Finish uninstalling.

If a system restart message appears, restart the computer by following the screen prompts. This completes the software uninstallation procedure.



NOTE

The software can also be uninstalled using the Product Library.

In the Product Library screen, select to uninstall, and follow the on-screen instructions to uninstall the software.

Basic Transmission

This section explains the basic procedure for sending a fax by Network FAX. An Adobe Acrobat document is sent as an example.

1 Create the document to be sent.

- 1 Use an application on your computer to create the document to be sent.
- 2 Set the original size and orientation.
- 3 Select **[Print]** from the File menu. The Print dialog box for the application that you are using will appear.

2 Select settings in the Print dialog box.

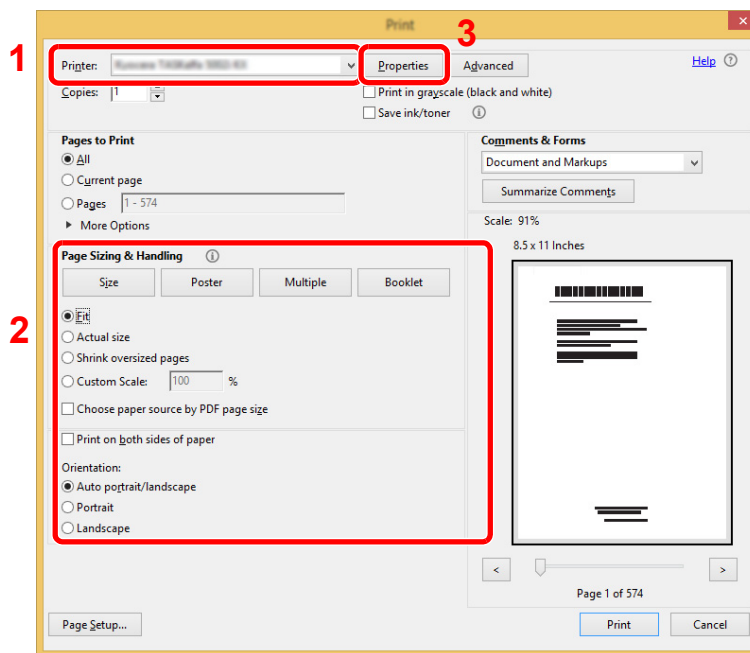

- 1 Select the product name of the machine (XXX XXX NW-FAX) to be used in the printer name list.
- 2 Set the print range and other settings.



NOTE

Make sure that the number of copies is set to 1. The following screen is an example. The actual dialog box will vary depending on the application that you are using.

- 3 Click **[Properties]** to open the Properties window.

3 Select settings on the FAX Setting tab.

- 1 Specify fax settings such as the original size on the FAX Setting tab, and click [OK].

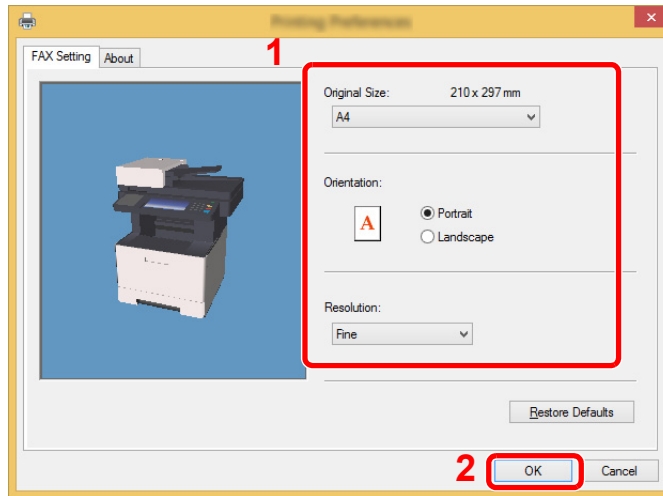

For detailed information on the settings on the tab, refer to the following:

- ➔ [Configuring the Driver Default Settings \(page 6-10\)](#)

- 2 You will return to the Print dialog box for the application. Click [OK]. The Transmit Settings dialog box will appear.

4 Select settings in the Transmit Settings dialog box.

You can specify settings such as a transmission time or a sub-address in the Transmit Settings dialog box.

For details on the settings, refer to the following:

- ➔ [Changing Transmit Settings \(page 6-14\)](#)

5 Specify a cover page.

To include a cover page, select settings on the [Cover Page] tab.

For details on the settings, refer to the following:

- ➔ [Using Cover Pages \(page 6-19\)](#)

6 Set the destination.

- 1 Use the keyboard to enter the destination fax number in the **[Address Setting]** tab.
 - Maximum number of characters that can be entered: 64 characters
 - Characters that can be entered: 0 to 9, #, *, -, space (a space or “-“ CANNOT be entered as the first character)
- 2 Click **[Add to Destination List]**. The destination information will appear in the address list. To send to multiple destinations, repeat this operation.
- 3 To use the Address Book, click **[Select from Address Book]** and select the destination.

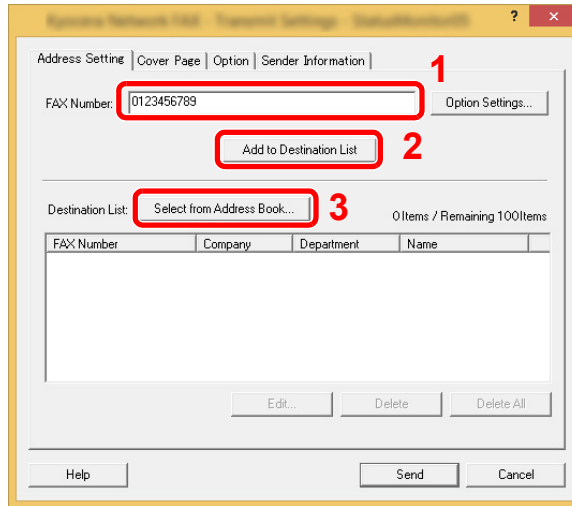

- 7 Click **[Send]**. Transmission will begin.

Configuring the Driver Default Settings

Use the FAX Setting tab of the print settings screen to set the original size and other transmission conditions.

1 Display the screen.

- 1 From the start button, click [**Control Panel**], [**Hardware and Sound**], and [**Devices and Printers**].
- 2 Right-click the product name of the machine you are using and select [**Printing preferences**] from the drop-down menu. The Printing Preferences screen will open.

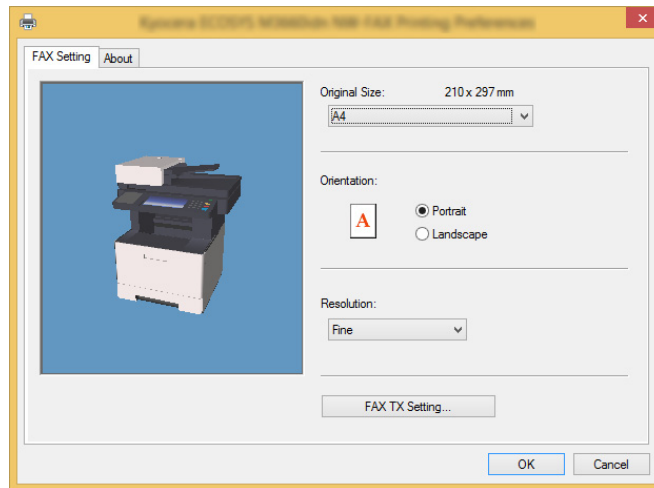

2 Select settings.

The following settings can be specified.

Item	Description
Original Size	Select the size of the document being transmitted from the drop-down list. Available settings: Letter, Legal, Statement, A4, A5, Folio, B5(JIS)
Orientation	Specify whether the orientation of the document is portrait or landscape. Available settings: Portrait, Landscape
Resolution	Select the resolution of the document to be transmitted from the drop-down list. Available settings: Normal, Fine, Ultra fine
FAX TX Setting	Click [FAX TX Setting] to change the default settings for fax transmission. The Default Settings dialog box will appear.

Default Settings Dialog Box

By setting the transmission conditions that you use most in this dialog box, you can minimize the need to change the settings each time.

The Default Settings dialog box can be accessed by the following procedure:

1 Display the screen.

- 1 In charms on Desktop, click **[Settings]**, **[Control Panel]**, and then **[Devices and Printers]**.

NOTE



In Windows 7, click **[Start]** button on the Windows, and then click **[Devices and Printers]**. In Windows 10, click **[Start]** button on the Windows, **[Control Panel]**, **[hardware and sound]**, and then **[Devices and Printers]**.

- 2 Right click the name of the machine to be used as the network fax and select **[Printing preferences]** from the resulting drop-down menu. Click the **[FAX TX Setting]** button in the **[Printing Preferences]** window.

2 Configure the settings.

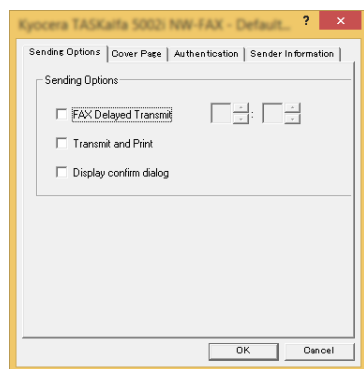
- (1) Sending Options Tab



Item	Description
FAX Delayed Transmit checkbox	<p>Check the checkbox in order to activate the time fields to the right of the checkbox whenever you want to set the time that your documents will be transmitted. The desired time setting can be entered directly with the keyboard or by clicking on the ▲ and ▼ arrows.</p> <p> IMPORTANT If the time that is shown in the message display of this fax machine does not match the current time, communications that use the timer may not be accomplished as expected. If the displayed time is not current, be sure to adjust it to match the correct time.</p> <p> NOTE If you designate a time that is earlier in the day than the time that is actually displayed in the fax machine itself, the transmission operation will be carried out the following day at that time. Be sure to confirm the time setting in the fax machine itself before making this setting.</p> <p>Value: 00:00-23:59</p>

Item	Description
Transmit and Print checkbox	Check the checkbox when you want to print out the documents at the fax machine same time as you send them by fax.
Display confirm dialog checkbox	You can check the checkbox to display the destination confirmation screen and check the destinations before transmission.

(2) Cover Page Tab

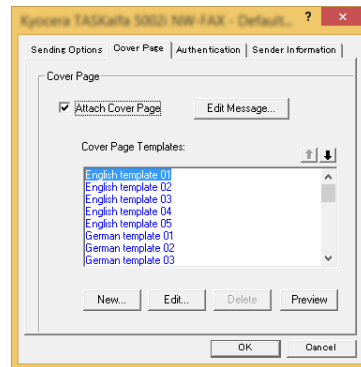

Item	Description
Attach Cover Page checkbox	Check the checkbox when you want to add a cover page to your transmission.

(3) Authentication Tab

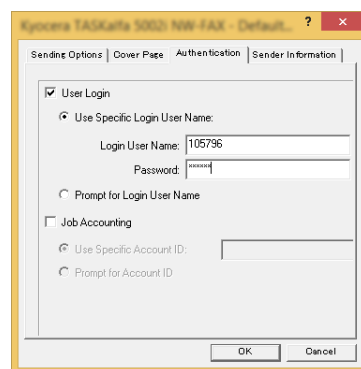

Item	Description
User Login checkbox	If the fax machine is set to User Login, select either Use Specific Login User Name or Prompt for Login User Name as desired. Use Specific Login User Name: Enter the Login User Name and Password. Transmission will be performed using the entered Login User Name and Password. Prompt for Login User Name: A screen for entering the Login User Name and Password will be displayed when attempting a transmission. The Login User Name and Password must be entered each time a transmission is attempted.
Job Accounting checkbox	If the fax machine is set to Job Accounting, select either Use Specific Account ID or Prompt for Account ID as desired. Use Specific Account ID: Enter the Account ID. Transmission will be performed using the entered Account ID. Prompt for Account ID: A screen for entering the Account ID will be displayed when attempting a transmission. The Account ID must be entered each time a transmission is attempted.

(4) Sender Information Tab

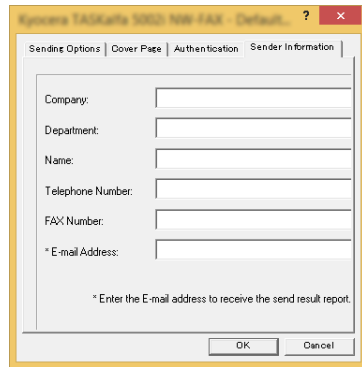

Enter your own information into fields explained below to send a cover page with your faxes.

Item	Description
Company	A maximum of 64 characters can be entered.
Department	A maximum of 64 characters can be entered.
Name	A maximum of 32 characters can be entered.
Telephone Number	A maximum of 20 characters can be entered. (Entry is allowed for the characters 0 to 9, #, *, -, (,), +, and spaces.)
FAX Number	A maximum of 20 characters can be entered. (Entry is allowed for the characters 0 to 9, #, *, -, (,), +, and spaces.)
E-Mail Address	A maximum of 128 characters can be entered. Available characters: Symbols (!, #, \$, %, &, ', *, +, -, ., /, =, @, [,], ^, _ , ` , { and }) Alphanumerics (0 – 9, A – Z and a – z)

 **NOTE**

Entering the e-mail address makes it possible to receive the transmission results report by e-mail. The fax machine must be set to transmit e-mail.

➔ *Machine's Operation Guide*

Changing Transmit Settings

(1) Selecting a Destination from the Address Book

There are two types of Address Books from which you can select the party to transmit to. They are the fax machine's Address Book and Windows Address Book.

 **NOTE**

There are three types of Address Books from which you can select the party to transmit to. They are the fax machine's Address Book, Windows Address Book, and the Address Book for the Network FAX data file (.fdt).

When using the fax machine's Address Book, the party must be registered in the fax machine's Address Book.

➔ [Registering Destinations in the Address Book \(page 2-11\)](#)

1 Click the [Select from Address Book] button.

The Address Selection dialog box opens.

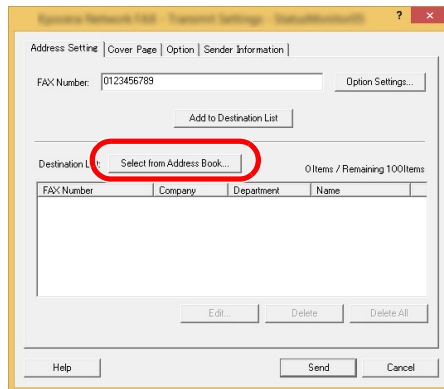

2 Select the desired Address Book.

To select the Address Book registered in the fax machine, select [**Address Book/XXXX (model name)**] from the drop-down menu.

 **NOTE**

To use the Windows Address Book, select [**Windows Address Book**].

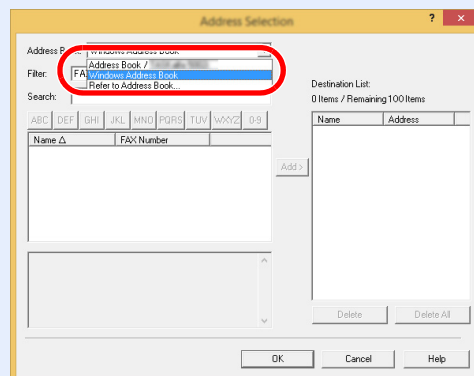

For adding an Address Book for Network FAX data file (.fdt), select the [**Refer to Address Book**], click on the [**Add**] button, and then select the [**Address Book data file**].

3 Select the Destination.

The destinations registered in the Address Book are shown in the list on the left side of the dialog box. To select a group of destinations, select **[Group]** from the filter's drop-down menu.

Select the desired destination and click on the **[Add>]** button. The selected destination will be added to the **[Destination List]** (right side).

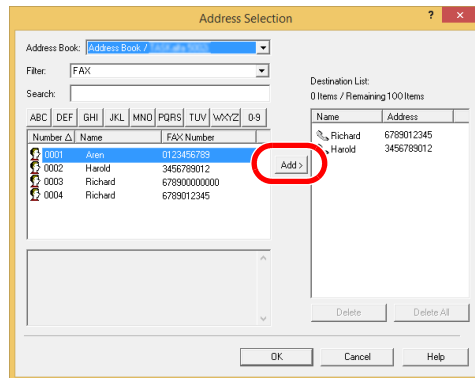

NOTE

- The list can be sorted. Click on the list item by which you want to sort the list (No., Recipient, Fax Number, Address). Δ or ∇ are displayed next to the sorted items. In addition, the corresponding destinations can be selected using the sorted items by entering a search character string in the Search field.
- When a destination is selected, the destination details are displayed in the field at the bottom of the list. When a group is selected, the members of the group are displayed in the field at the bottom of the list. When the group includes members for which multiple fax numbers are registered, a fax number selection screen will be displayed.

To delete any of the destinations from the Destination List, select that destination and then click on the **[Delete]** button. To delete all of the destinations from the Destination List, click on the **[Delete all]** button.

4 Click on the [OK] button.

The **[Transmit Settings]** dialog box will be displayed once again.

(2) Subaddress-Based Communication



NOTE

In order to conduct sub address communication, the other party's system also needs to be equipped with sub address communication functions of the same type.

1 Open the Option Settings dialog box.

Click on the [Option Settings] button in the [Address Setting] tab of the [Transmit Settings] dialog box.

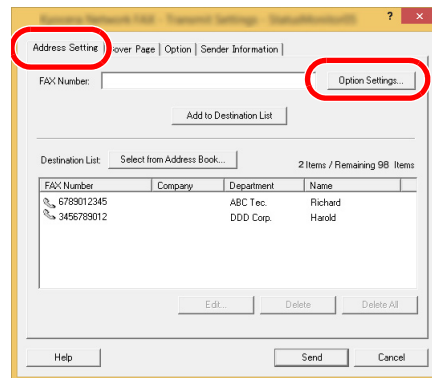

2 Enter the sub-address and password as it is registered in the destination fax.

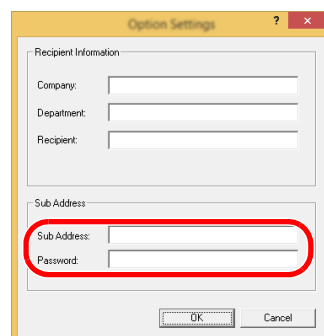

- Maximum number of characters that can be entered: 20 characters
- Characters that can be entered: 0 to 9, #, *, space (a space CANNOT be entered as the first character)

3 Click on the [OK] button.

The [Transmit Settings] dialog box will be displayed once again.

(3) Cover Page Settings

A Cover Page can be set as the first page of a fax transmission. In addition to the standard templates for Cover Pages, original templates can be created and used.

To attach and transmit a Cover Page, place a check in the check box for **[Attach Cover Page]** in the **[Cover Page]** tab.

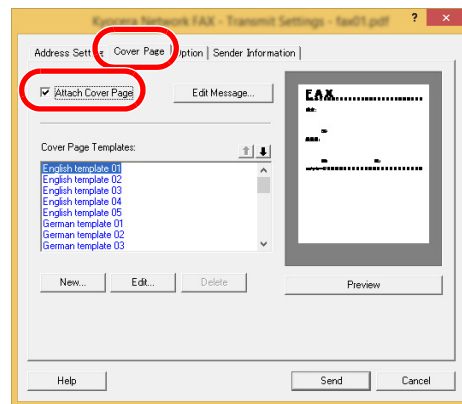

For more information how to use the cover page, refer to the following:

➔ [Using Cover Pages \(page 6-19\)](#)

(4) Optional Settings

The settings that were selected in “(1) Sending Options Tab” can be changed by clicking the **[Options]** tab.

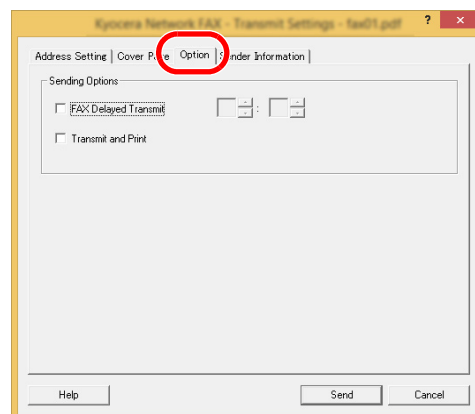

For the setting procedures, refer to the following:

➔ [\(1\) Sending Options Tab \(page 6-11\)](#)

(5) Transmitting Terminal Information Data

The settings that were selected in “(4) Sender Information Tab” can be changed by clicking the [Sender Information tab].

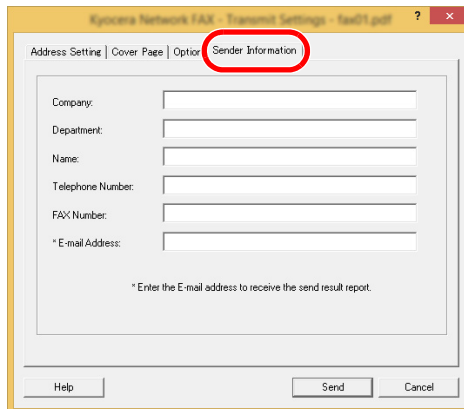

Using Cover Pages

Cover Page Selection (Transmission Settings)

The Cover Page is attached to the fax and sent as the first page.

About Cover Pages

The Cover Page can be selected from a template. The Cover Page contains such destination information and sender information as that shown below.

Sample of English template 01

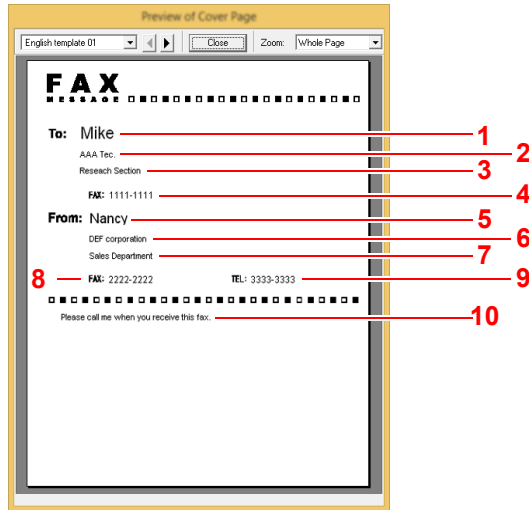

No.	Item
1	Recipient Name
2	Destination Company Name
3	Destination Department Name
4	Destination Fax number
5	Sender Name
6	Sender Company Name
7	Sender Department Name
8	Sender Fax Number
9	Sender Telephone Number
10	Message

Attaching and Transmitting a Cover Page

1 Open the Transmit Settings dialog box.

Perform Steps 1 to 7 of the Basic Transmission method to display the Transmit Settings dialog box.

➔ [Basic Transmission \(page 6-7\)](#)

When selecting the destination from an Address Book, refer to “(1) Selecting a Destination from the Address Book”, select the destination, and go to Step 4.

➔ [\(1\) Selecting a Destination from the Address Book \(page 6-14\)](#)

2 Enter the fax number.

In the [Address Setting] tab, enter the destination fax number and click on the [Option Settings] button.

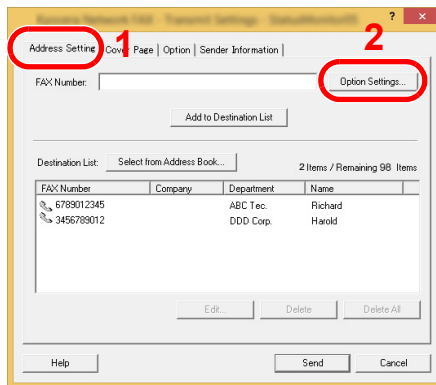

Item	Description
FAX Number	A maximum of 64 characters can be entered.

3 Enter the recipient information.

When finished, click the [OK] button.

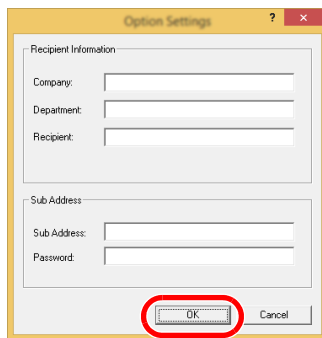

Item	Description
Company	A maximum of 32 characters can be entered.
Department	A maximum of 32 characters can be entered.
Recipient	A maximum of 32 characters can be entered.



NOTE

When [Attach Cover Page] of the [Cover Page] Tab is not set, the Cover Page Confirmation screen will be displayed.

To include a cover page, click on [Attach Cover Page] button.

4 Add the destination to the destination list.

- 1 Add this information to the [Destination List] by clicking on the [Add to Destination List] button.
- 2 To change the recipient information of a destination that has been added to the [Destination List], select the destination to be changed and click on the [Edit] button. Change the recipient information and click on the [OK] button.

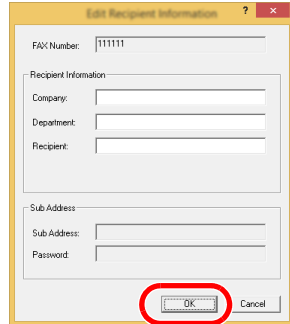

Item	Description
FAX Number	The fax number cannot be changed.
Company	A maximum of 32 characters can be entered.
Department	A maximum of 32 characters can be entered.
Recipient	A maximum of 32 characters can be entered.

- 3 When the sender information is not set in the [Default Settings] dialog box, click on the [Sender Information] tab and set the sender information.

➔ [\(4\) Sender Information Tab \(page 6-13\)](#)

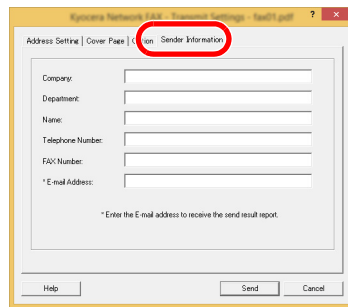

Item	Description
Company	A maximum of 64 characters can be entered.
Department	A maximum of 64 characters can be entered.
Name	A maximum of 32 characters can be entered.
Telephone Number	A maximum of 20 characters can be entered. (Entry is allowed for the characters 0 to 9, #, *, -, (,), +, and spaces.)
FAX Number	A maximum of 20 characters can be entered. (Entry is allowed for the characters 0 to 9, #, *, -, (,), +, and spaces.)
E-mail Address	A maximum of 128 characters can be entered. Available characters: Symbols (!, #, \$, %, &, ', *, +, -, ., /, =, @, [,], ^, _, ` , { and }) Alphanumerics (0 – 9, A – Z and a – z)

5 Attach a Cover Page.

Click on the **[Cover Page]** tab and place a check in the **[Attach Cover Page]** checkbox.

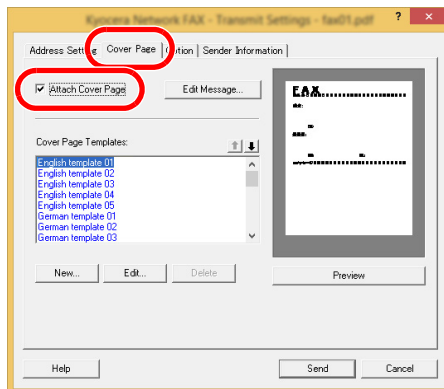

6 Select the Cover Page to be attached.

Select a Cover Page template from the **[Cover Page Templates]** list.



NOTE

If the Cover Page is registered in the Default Settings, then the action of selecting the Cover Page for each transmission can be omitted.

➔ [Cover Page Registration \(Default Settings\) \(page 6-24\)](#)

Original Cover Page templates can be created.

➔ [Creating New Cover Page Templates \(page 6-26\)](#)

7 Check the contents of the Cover Page.

1 Click on the **[Preview]** button. A preview of the currently selected template will be displayed.

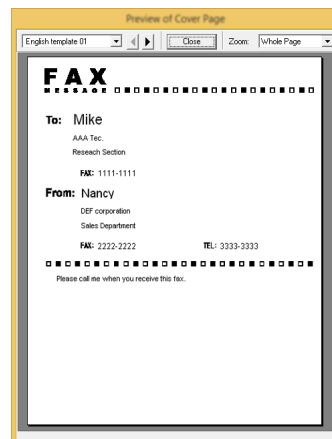

To display a different template, use the drop-down menu at the top of the dialog box or click on the **[◀]** or **[▶]** button. The template display magnification can also be changed within the range of 25 to 250% from the drop-down menu.



IMPORTANT

Before transmitting the fax, be sure to use the Preview screen to check all of the displayed information including the recipient name and company name. If there is a large number of characters for information that is automatically entered, they might not completely fit in the field and the characters might not print correctly. If the characters are not displayed correctly, reduce the number of characters in the recipient information or sender information or edit the template being used.

2 Click on the **[Close]** button.

8 Edit the Message.

1 Click on the **[Edit Message]** button.

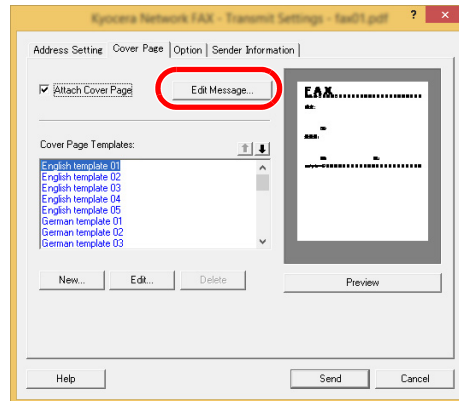

2 Enter the message to be added to the Cover Page and click on the **[OK]** button.

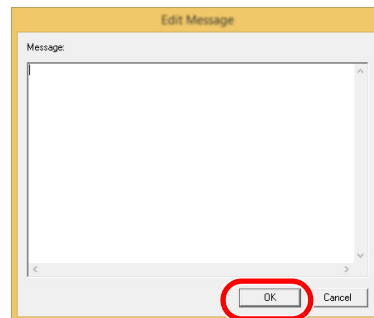

Item	Description
Message	A maximum of 1,000 characters can be entered.

9 Transmit.

Click on the **[Send]** button to begin the transmission.

Cover Page Registration (Default Settings)

If the Cover Page is registered in the Default Settings, the action of selecting the Cover Page for each transmission can be omitted.

Template Selection

Select the Cover Page template to be registered in the Default Settings. The registration method is as follows.

1 Open the Default Settings dialog box.

Perform the Default Settings Dialog Box procedure, open the [Default Settings] dialog box.

➔ [Default Settings Dialog Box \(page 6-11\)](#)

2 Attach a Cover Page.

Click on the [Cover Page] tab and place a check in the [Attach Cover Page] checkbox.

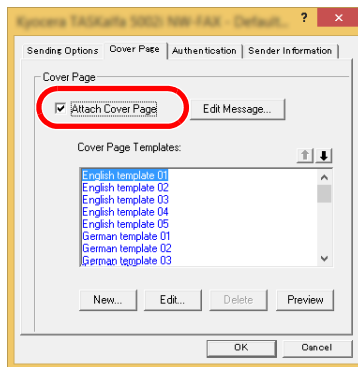

3 Select the Cover Page to be attached.

Select a Cover Page template from the [Cover Page Templates] list.



NOTE

Original Cover Page templates can be created.

➔ [Creating New Cover Page Templates \(page 6-26\)](#)

4 Check the contents of the Cover Page.

- 1 Click on the **[Preview]** button. A preview of the currently selected template will be displayed.

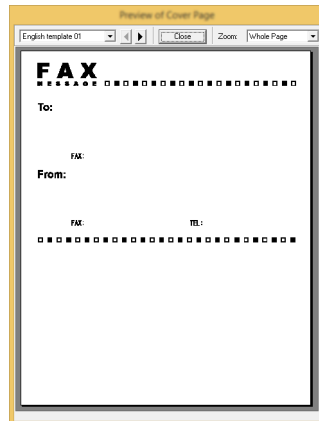

To display a different template, use the drop-down menu at the top of the dialog box or click on the **[◀]** or **[▶]** button. The template display magnification can also be changed within the range of 25 to 250% from the drop-down menu.

- 2 Click on the **[Close]** button.

5 Edit the Message.

- 1 Click on the **[Edit Message]** button.

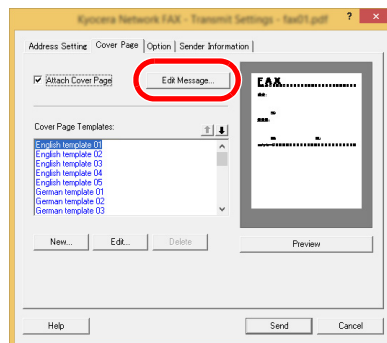

- 2 Enter the message to be added to the Cover Page and click on the **[OK]** button. A maximum of 1,000 characters can be entered.

6 Click on the **[OK]** button.

Sender Information Registration

Please register the sender information to be included on the Cover Page.



NOTE

For information regarding the registration method, refer to the following:

➔ [\(4\) Sender Information Tab \(page 6-13\)](#)

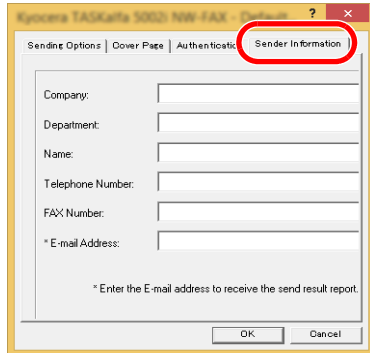

Creating New Cover Page Templates

Perform the following procedure to create an original Cover Page template.

1 Open the Default Settings dialog box.

Perform the Default Settings Dialog Box procedure, open the **[Default Settings]** dialog box.

➔ [Default Settings Dialog Box \(page 6-11\)](#)

2 Edit the Cover Page templates.

1 Place a check in the **[Attach Cover Page]** checkbox and click on the **[New...]** button. The **[Edit Cover Page]** screen will be displayed.

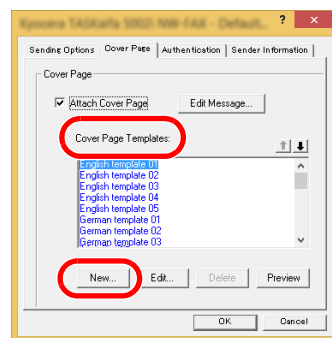

2 Enter the characters.

From the Menu bar, click on **[Insert]** and then **[Textbox]** and then position the textbox and enter the characters.

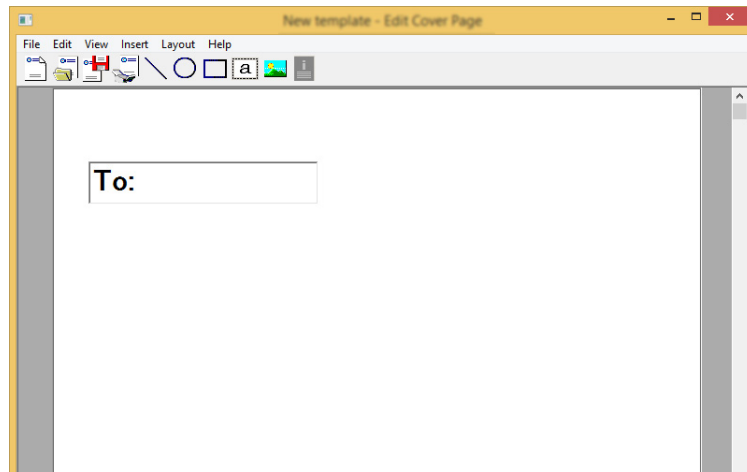

3 Position the field box.

From the Menu bar's **[Insert]** menu, select the field box to be positioned.

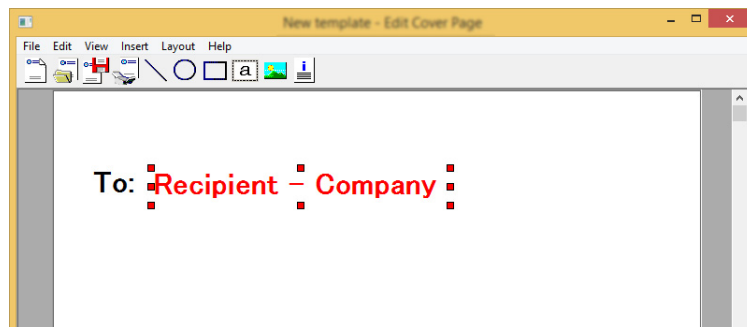

IMPORTANT

If there are too many characters in the entered information, such as recipient name or company name, the information will not fit in the field box and some of the characters could be cut off. When positioning the field box, make it large enough and adjust the font point size so that the inserted information will fit in the field box.

NOTE

When a fax is transmitted, the information entered in the Default Settings and Destination Settings will automatically be entered in the fields.

The following field boxes can be used. Use them as required.

Menu Item		Template Display	Inserted Information
Destination	Company	Recipient - Company	Recipient information company name
	Department	Recipient - Department	Recipient information department name
	Name	Recipient - Name	Recipient information recipient name
	Address	Recipient - Address	Recipient FAX number

Menu Item		Template Display	Inserted Information
Sender	Company	Sender - Company	Sender information company name
	Department	Sender - Department	Sender information department name
	Name	Sender - Name	Sender information sender name
	FAX Number	Sender - FAX Number	Sender information FAX number
	Telephone Number	Sender - Telephone Number	Sender information telephone number
Comment		Comment	Message entered in the Cover Page tab

- 4 Position the figures, textboxes, etc., to create a Cover Page.



NOTE

For information regarding the operation method, refer to Help.

- 5 From the Menu bar click on **[File]** and then **[Save As]**, enter the file name, and click on the **[Save]** button.

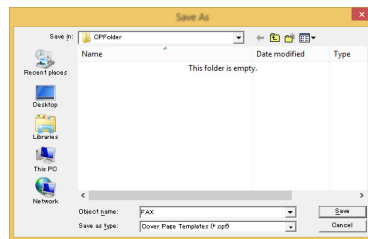

- 6 Close the **[Edit Cover Page]** screen.

- 7 The new template will be registered at the top of the list and can now be selected.

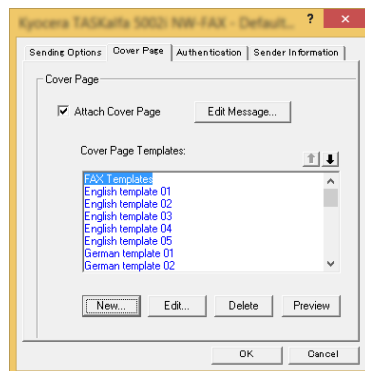

Transmission Control

Perform the following procedure when you want to use your computer to verify the status of a fax transmission currently being processed, or to actually terminate that transmission.

Once a fax transmission starts being processed, a Transmission Control icon will be displayed in the Windows Task Bar.

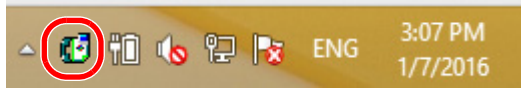

- 1 **Double-click on that icon to access the Transmission Control window which indicates the status of all transmissions being processed.**

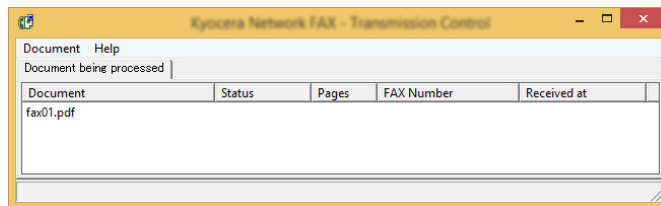

To terminate any transmission, select that transmission and then select **[Cancel]** from the **Document** menu.

Ending Transmission Control

Right click on the Transmission Control icon and select **[Exit]**.

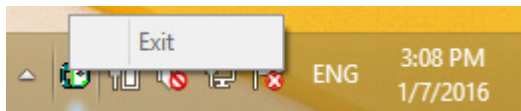

7 Managing Jobs

This chapter explains the following topics:

Various Tools for Checking Transmission Results and Registration Status	7-2
Checking FAX Job History	7-3
Displaying Job Log Screen	7-3
Printing Administrative Reports (Result Report Setting)	7-4
Send Result Reports	7-4
Attached image when a network fax is sent	7-4
Report for Job Canceled before Sending	7-5
FAX RX Result Reports	7-6
Activity Report (Outgoing FAX Report and Incoming FAX Report)	7-7
Printing Activity Reports	7-7
Automatic Printout	7-7
Status Page	7-8
Reporting FAX Receipt Result by E-mail	7-9
Confirmation Screen of Destinations	7-10

Various Tools for Checking Transmission Results and Registration Status

Check the fax transmission results and registration status using the following tools.

Tool	Display Location	Contents to Check	Timing of Check	Reference Page
FAX job history check	Touch panel	History of latest 50 send and receipt results stored	Any time	7-3
Send result report / Receipt result report	Report printing	Latest send or receipt result	Automatic printout after every sending or receiving operation (No Print Output or Error Only is also optionally available.)	7-4
Activity report	Report printing	Latest 50 send or receipt results	Any time, and automatic printout after every 50 sending/receiving	7-7
Status page	Report printing	Registration status of Local FAX Number, Local FAX Name, fax line setting, etc.	Any time	7-8
Reporting of FAX receipt result by Email	PC	Fax receipt	Fax reception is reported by e-mail.	7-9

Checking FAX Job History

Display the history of the latest 50 each of send and receipt results on the display for checking.

 **NOTE**
Even when job accounting is enabled, 50 each of send and receipt results are displayed regardless of the account ID.
For details of the job history check, refer to the following:
➔ *Machine's Operation Guide*

Displaying Job Log Screen

1 Display the screen.

[Status/Job Cancel] key > [FAX Job Log] > [Outgoing FAX Log] or [Incoming FAX Log]

 **NOTE**
To check the fax save log, select [Status/Job Cancel] key > [Store Job Log].

2 Check

1 Select [...] for the job in the list that you want to check. A screen showing details will appear.



2 Select [Close] to exit.

Printing Administrative Reports (Result Report Setting)

You can print various administrative reports to check the results of fax transmission or the status of the functional setup.

Send Result Reports

Each time you send a fax, you can print a report to confirm whether the fax was sent successfully. You can also print the transmitted image in the send result report.

1 Display the screen.

[System Menu/Counter] key > [Report] > [Result Report Setting] > [Send Result Report] > [FAX]

2 Configure the function.

- 1 Select [Off] (not to print), [On] (to print), [Error Only], or [Specify Each Job].



NOTE

When [Specify Each Job] is selected, it is possible to set a send result report when transmitting.

➔ [FAX TX Report \(page 3-23\)](#)

- 2 If you selected [On], [Error Only] or [Specify Each Job], specify whether the transmitted image is to be attached by selecting [Off] (do not print transmitted image), [Partial Image] (print part of the transmitted image at full size), or [Full Image] (print the entire transmitted image at reduced size).

With transmitted image

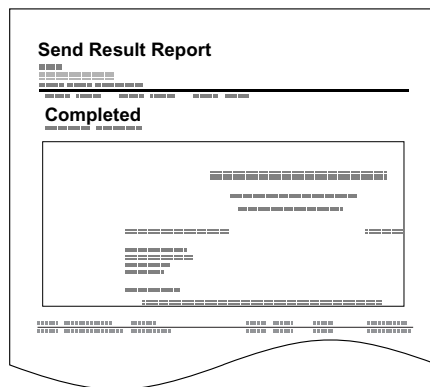

Without transmitted

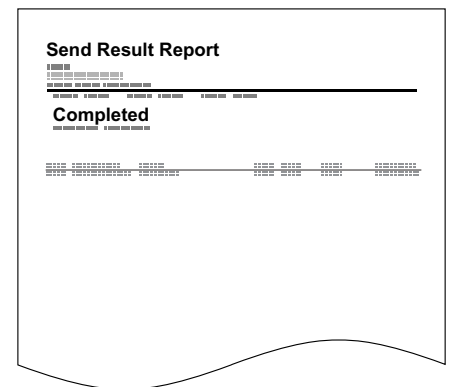

Attached image when a network fax is sent

Select whether the image to be attached to an Activity Report will be [Body] or [Cover Page], when using network fax.

1 Display the screen.

[System Menu/Counter] key > [Report] > [Result Report Setting] > [Send Result Report] > [Attach Image of Network FAX]

2 Configure the settings.

Select [Body] or [Cover Page].

Report for Job Canceled before Sending

Print a send result report when the job is canceled before being sent.



NOTE

This is not displayed if E-mail/Folder and Fax are both set to **[Off]** in Send Result Reports.

1 Display the screen.

[System Menu/Counter] key > [Report] > [Result Report Setting] > [Send Result Report] > [Canceled before Sending]

2 Configure the function.

Select **[Off]** or **[On]**.

Recipient Format

Select the Recipient Format for the send result report.

The name and destination that appear on the Send Result Report are taken from the information stored in the address book.

If **[Name or Destination]** is selected, either the name (destination name) or the destination (FAX No.) stored in the address book is shown.

If **[Name and Destination]** is selected, both the name (destination name) and destination (FAX No.) are shown.

When the destination was directly entered, only the destination (FAX No.) is shown.



NOTE

This is not displayed if E-mail/Folder and Fax are both set to **[Off]** in Send Result Reports.

1 Display the screen.

[System Menu/Counter] key > [Report] > [Result Report Setting] > [Send Result Report] > [Recipient Format]

2 Configure the function.

Select **[Name or Destination]** or **[Name and Destination]**.

FAX RX Result Reports

Each time you receive a fax, you can print a report to confirm whether the fax was received successfully.



NOTE

Fax receipt can also be notified by e-mail instead of checking the receipt result report.

➔ [Reporting FAX Receipt Result by E-mail \(page 7-9\)](#)

1 Display the screen.

[System Menu/Counter] key > [Report] > [Result Report Setting] > [RX Result Report] > [FAX]

2 Configure the function.

Select [Off] (not to print), [On] (to print), or [Error/SubAddress].

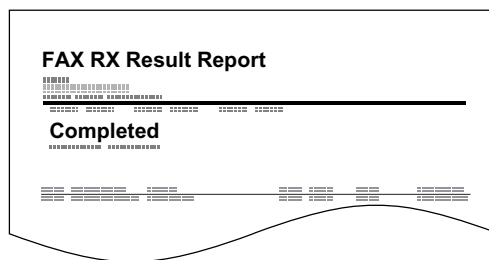

Activity Report (Outgoing FAX Report and Incoming FAX Report)

Activity reports are reports of both the sent faxes and the received faxes. Each report lists the history of the latest 50 sent or received fax data. When automatic printout is selected, a report is printed out automatically after every 50 faxes sent or received.

Printing Activity Reports

The latest 50 sent or received fax data are printed as a report.

1 Display the screen.

[Status/Job Cancel] key > [FAX Job Log]

2 Print

1 Select [Outgoing FAX Report] to print the sent fax report, and select [Incoming FAX Report] to print the received fax report.

2 Select [Yes].
The report is printed.

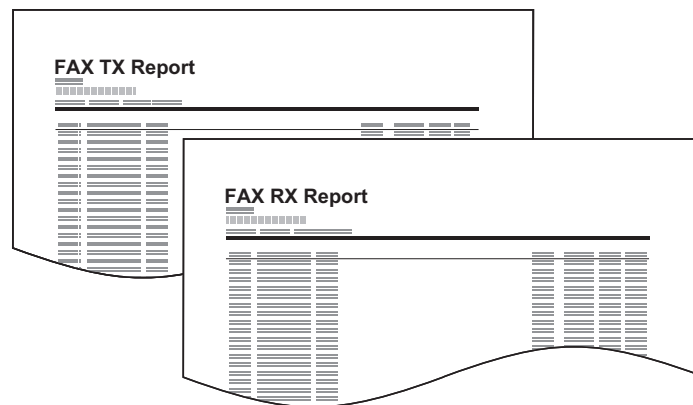

Automatic Printout

An activity report is printed out automatically after every 50 faxes sent or received.

1 Display the screen.

[System Menu/Counter] key > [Report] > [Admin Report Settings] > [Outgoing FAX Report] or [Incoming FAX Report]

2 Configure the function.

Select [Off] (not to print) or [On] (to print).

Status Page

A status page provides information on a number of user setups. FAX-related information includes the Local FAX Number, Local FAX Name, fax line setting, etc. You can print it out as necessary.

1 Display the screen.

[System Menu/Counter] key > [Report] > [Report Print]

2 Print

[Status Page] > [Yes]

A status page is printed.

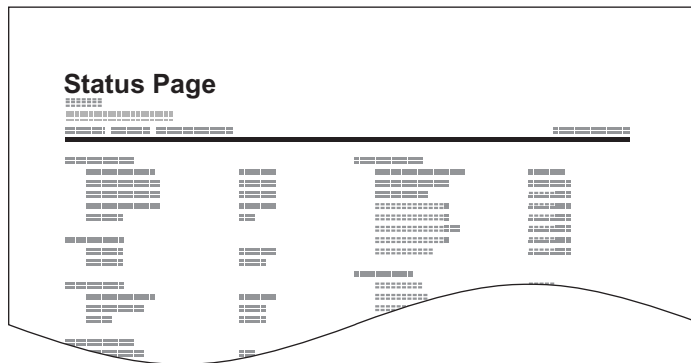

Reporting FAX Receipt Result by E-mail

Fax receipt can also be notified by e-mail instead of checking the receipt result report.

```

Job No.: 000019
Result: OK
End Time: Sun 24Oct2010 14:53:38
File Name: doc23042006145300

Result Job Type Address
-----
OK FAX 123456

-----
XX-XXXX
[00:c0:ee:1a:01:24]
-----
    
```



NOTE

This setting is displayed when the FAX RX Result Report setting is **[On]** or **[Error/SubAddress]**.

➔ [FAX RX Result Reports \(page 7-6\)](#)

If the setting is **[Error/SubAddress]**, E-mail notification is provided when an error occurs or a sub-address fax is received.

1 Display the screen.

[System Menu/Counter] key > [Report] > [Result Report Setting] > [RX Result Report] > [RX Result Report Type]

2 Select the destination.

Select from the address book

1 [E-mail] > [+] > [Address Book]

2 Select the destination from the Address Book and select **[OK]**.



NOTE

For details on selecting the destination from the Address Book, refer to the following:

➔ [Choosing from the Address Book \(page 3-9\)](#)

Enter the E-mail address

1 [E-mail] > [+] > [Address Entry]

2 Enter the address of the destination and select **[OK]**.

For details on character entry, refer to the following:

➔ [Character Entry Method \(page 10-2\)](#)

Confirmation Screen of Destinations

When selecting [**On**] for Dest. Check before Send, the confirmation screen of destinations appears after pressing the [**Start**] key.

➔ Machine's *Operation Guide*

Follow the steps below to confirm the destinations.

1 Check all destinations.

Select [^] or [v] to confirm every destination. Select [...] to display the detailed information on the selected destination.



NOTE

Be sure to confirm every destination by displaying them on the touch panel. You cannot select [**Check**] unless you have confirmed every destination.

2 Change a destination.

Delete a destination

1 To delete the destination, select the destination you want to delete and select [🗑️].

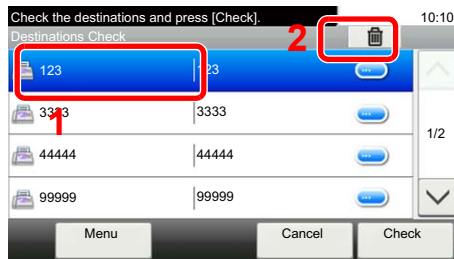

2 Select [**Yes**].
The destination is deleted.

Add a destination

To add the destination, select [**Cancel**] and then return to the destination screen.

3 Select [**Check**].

When you have finished checking all destinations, select [**Check**].

4 Press the [**Start**] key.

Start sending.

8 Fax Settings

This chapter explains the following topics:

Default fax settings	8-2
Operation method	8-2
System Menu Settings	8-3
Report	8-4
Cassette/MP Tray Settings	8-5
Common Settings	8-5
Document Box	8-6
FAX	8-7
Transmission Restriction	8-11
Registering Permit FAX No.	8-12
Changing and Deleting Permit FAX No.	8-13
Registering Reject FAX No.	8-14
Changing and Deleting Reject FAX No.	8-15
Registering Permit ID No.	8-16
Changing and Deleting Permit ID No.	8-17
Setting Send Restriction	8-18
Setting Reception Restriction	8-18
Unknown Number Reception	8-18
Unusable Time	8-19
Account Management	8-20

Default fax settings

This section explains the fax settings in the system menu.

Operation method

The system menu is operated as follows:

1 Display the screen.

Select the [System Menu/Counter] key.

2 Select a function.

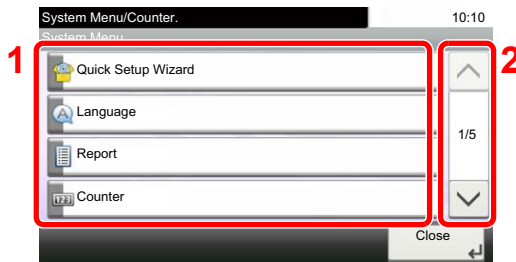

1 Displays the System Menu items.

2 Scrolls up and down when the list of values cannot be displayed in its entirety on a single screen.

3 Displays setting items. Select the key of a function to display the setting screen.

4 Returns to the previous screen.

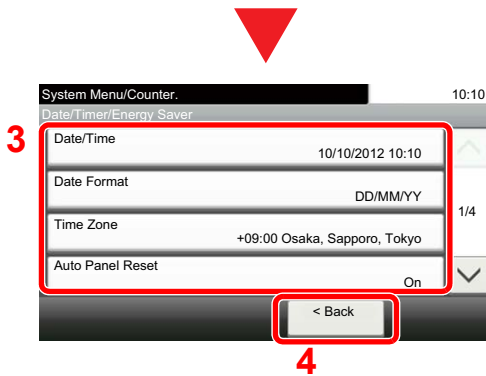

3 Configure the function.

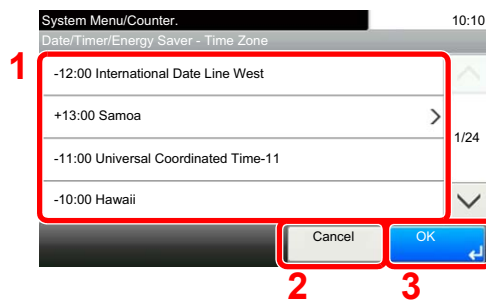

1 Selecting a value it to be accepted.

2 Returns to the original screen without making any changes.

3 Accepts the settings and exits.

NOTE

If the login user name entry screen appears during operations, log in by referring to the machine's *Operation Guide* for Administrator User Name and Password.

The factory default login user name and login password are set as shown below.

	P-4536i MFP	P-5536i MFP	P-6036i MFP
Login User Name:	4500	5500	6000
Login Password:	4500	5500	6000

If function default settings have been changed, the [Reset] key can be selected in each function screen to immediately change the settings.

Refer to *System Menu Settings* on the following page and configure as needed.

System Menu Settings

Settings for the fax function in the system menu are shown below.



NOTE

For settings other than fax settings, refer to the following:

➔ [Machine's Operation Guide](#)

Item	Description	Reference Page
Quick Setup Wizard	Configures settings for the machine in a wizard format.	—
FAX Setup	Configures fax settings in a wizard format.	2-7
Report	Print reports to check the machine settings and status. Default settings for printing the result reports can also be configured.	8-4
Cassette/MP Tray Settings	Select paper size and media type for Cassette 1 to 5 and multi purpose tray.	8-5
Common Settings	Configures overall machine operation.	8-5
Document Box	Configures settings related to the Sub Address Box, Polling Box and FAX Memory RX Box. For details on Sub Address Box, refer to the following: ➔ Sub Address Box Function (page 5-8) For details on Polling Box, refer to the following: ➔ Polling Communication (page 5-15) For details on FAX Memory RX Box, refer to the following: ➔ FAX Memory RX Box (page 5-21)	8-6
FAX	Configures settings for fax functions.	8-7
Address Book/One Touch	Configures Address Book and One Touch Key settings. For details on Address Book, refer to the following: ➔ Adding a Destination (Address Book) (page 2-11) For details on One Touch Key, refer to to the following: ➔ Adding a Destination on One Touch Key (page 2-17)	—
Date/Timer/Energy Saver	Set the date and time for the location where you use the machine. For details, refer to the following: ➔ Setting Date and Time (page 2-9) This feature sets a time period during which the machine will not print received faxes. For details, refer to the following: ➔ Unusable Time (page 8-19)	—

Report

Print reports to check the machine settings and status. Default settings for printing the result reports can also be configured.

Report Print

Item	Description
Status Page	A status page provides information on a number of user setups. FAX-related information includes the Local FAX Number, Local FAX Name, fax line setting, etc. You can print it out as necessary. ➔ Status Page (page 7-8)
Sub Address Box List	You can print the Sub Address Box list in which the list of Box No.'s and Box names of the registered Sub Address Boxes are described. ➔ Printing from a Polling Box (page 5-19)
FAX List (Index)	You can print the list of destinations registered in the Address Book. You can sort the list in the order of names or address numbers of the destinations. ➔ Printing Address List (page 2-16)
FAX List (No.)	You can print the list of destinations registered in the Address Book. You can sort the list in the order of names or address numbers of the destinations. ➔ Printing Address List (page 2-16)
Outgoing FAX Report	The latest 50 sent fax data are printed as a report.
Incoming FAX Report	The latest 50 received fax data are printed as a report.

Admin Report Settings

Item	Description
Outgoing FAX Report	An activity report is printed out automatically after every 50 faxes sent. ➔ Activity Report (Outgoing FAX Report and Incoming FAX Report) (page 7-7)
Incoming FAX Report	An activity report is printed out automatically after every 50 faxes received. ➔ Activity Report (Outgoing FAX Report and Incoming FAX Report) (page 7-7)

Result Report Setting

Item	Description
Send Result Report	Each time you send a fax, you can print a report to confirm whether the fax was sent successfully. ➔ Send Result Reports (page 7-4)
RX Result Report	When a fax is received, you can be notified by receipt result report or e-mail. ➔ FAX RX Result Reports (page 7-6)
Job Finish Notice Setting	Attaches sent images to job finish notices. Value: Do Not Attach Image, Attach Image

Cassette/MP Tray Settings

Select paper size and media type for Cassette 1 to 5.

Cassette1 (to 5)

Item	Description
Paper Size	Set the paper size to load in Cassette 1 and optional paper feeders (Cassette 2 to 5). <input checked="" type="checkbox"/> IMPORTANT: Specify the paper size as follows for the cassette that you want to use for fax reception. Inch models: Letter, Legal, Statement Metric models: A4, B5, A5, Folio
Media Type	Set the media type to load in Cassette 1 and optional paper feeders (Cassette 2 to 5). Value: Plain, Rough, Recycled, Preprinted*, Bond, Color, Prepunched*, Letterhead*, Envelope**, Thick, High Quality or Custom 1-8

* Cannot be used to print received faxes.

** For cassettes 2 to 5 only.

Multi Purpose Tray

Item	Description
Paper Size	Set the paper size for multi purpose tray. <input checked="" type="checkbox"/> IMPORTANT: Specify the paper size as follows for the multi purpose tray that you want to use for fax reception. Inch models: Letter, Legal, Statement Metric models: A4, B5, A5, Folio
Media Type	Set the media type for multi purpose tray. Value: Plain, Rough, Transparency*, Vellum, Labels, Recycled, Preprinted*, Bond, Cardstock, Color, Prepunched*, Letterhead*, Envelope, Thick, High Quality, Custom 1-8

* Cannot be used to print received faxes.

Common Settings

Configures overall machine operation.

Sound

Item	Description
Buzzer	Set options for buzzer sound during the machine operations.
Job Finish	Emit a sound when a print job is normally completed. Value: Off, On, FAX Reception Only
FAX Speaker Volume	Adjust the volume of the speaker. Speaker Volume: Volume of the built-in speaker when the line is connected by selecting On Hook key. Value: [1] (Minimum), [2], [3] (Medium), [4], [5] (Maximum), [0] (Mute)
FAX Monitor Volume	Adjust the volume of the monitor. Monitor Volume: Volume of the built-in speaker when the line is connected without selecting On Hook key such as in memory transmission. Value: [1] (Minimum), [2], [3] (Medium), [4], [5] (Maximum), [0] (Mute)

Function Defaults

Item	Description
FAX TX Resolution	Select the default scanning resolution. Value: 400×400dpi Ultra Fine, 200×400dpi Super Fine, 200×200dpi Fine, 200×100dpi Normal
Continuous Scan (FAX)	Set the continuous scan defaults. Value: Off, On

Display Status/Log

Item	Description
Display FAX Log	Set the display method of the Status/Log. Value: Show All, Hide All

Function Key Assignment

Item	Description
Function Key 1	Assigns a function to each function key. Value: None, Copy, Send, FAX Server*, FAX, Custom Box**, Job Box, Removable Memory, Sub Address Box, Polling Box, FAX Memory RX Box, ID Card Copy, Paper Saving Copy, Simple Folder Send (Destination Entry), Simple Folder Send (Address Book), Simple Email Send (Destination Entry), Simple Email Send (Address Book), Application***  NOTE You can select the function to display by selecting [Menu] > [Narrow Down] or from the pull-down menu, by selecting [All], [Application], [Favorites], [Others] to display the function.
Function Key 2	
Function Key 3	

* Displayed when the external server (FAX server) is set.

** Displayed when the product is equipped with an optional large capacity storage device (SSD).

*** The registered application name is displayed.

Show Power Off Message

Item	Description
Show Power Off Message	Set the mode whether display a confirmation message in power supply off. Value: Off, On

Document Box

Configures settings for the FAX Memory RX Box.

FAX Memory RX Box

Item	Description
FAX Memory RX	Configure whether to save the received faxes one into the FAX Memory RX Box. Value: Off, On



FAX



Settings related to the fax function can be configured.

TX/RX Common

Item	Description
Encryption Key Registration	This is used to register an encryption key for encrypted communication. ➔ Encryption (page 5-23)
FAX Remote Diagnosis	If a problem arises with this machine and you contact our service representative, this feature enables our Service Center computer to access the machine over the phone and check the machine's status or look for problems.  NOTE: To use Remote Diagnostics, you must first sign an agreement with our service representative and register a Predetermined ID on the machine. For more information, contact your Service Representative or Authorized Service Center. Value: On, Off
Remote Diagnostics ID	If you have turned on Remote Diagnostics, enter the predetermined ID. Value: 0000 - 9999



Transmission

Item	Description
Local FAX Name	Register the local FAX name printed in the transmit terminal identification (TTI) area. This item is included in the Quick Setup Wizard. ➔ Quick Setup Wizard (Fax Setup) (page 2-7)
Local FAX ID	Register the local FAX ID. This item is included in the Quick Setup Wizard. ➔ Quick Setup Wizard (Fax Setup) (page 2-7)  NOTE: The Local FAX ID is used for transmission limit purposes. ➔ Transmission Restriction (page 8-11)
Local FAX Number	Register the local FAX number printed in the transmit terminal identification (TTI) area. This item is included in the Quick Setup Wizard. ➔ Quick Setup Wizard (Fax Setup) (page 2-7)
TTI	The transmit terminal identification (TTI) is the information about the sending machine (transmit terminal) that is printed by the receiving machine on the received fax. The information includes the date and time of transmission, number of pages sent, name and fax number. This machine enables the user to select if the TTI is printed out on the fax on the receiving system. Regarding the location of the information to be printed, you can select inside or outside of the page image being sent. Value: Off, Outside, Inside  NOTE: Normally, the Local FAX Name is printed in the transmit terminal identification (TTI). However, when job accounting has been enabled, and you send originals after entering an Account ID, the Account Name is printed. This item is included in the Quick Setup Wizard. ➔ Quick Setup Wizard (Fax Setup) (page 2-7)
Account Name Use	Select whether or not to use account name as local FAX name. Value: Off, On

Item	Description
Dialing Mode (Inch version only)	<p>Select the telephone line according to the type you are contracted with. Please note that selecting a wrong telephone line will prevent you from sending fax.</p> <p>Value: Tone(DTMF), Pulse(10PPS)</p> <p>This item is included in the Quick Setup Wizard.</p> <p>➔ Quick Setup Wizard (Fax Setup) (page 2-7)</p>
Retry Times	<p>The number of retry times can be changed automatically.</p> <p>Value: 0 - 14</p> <p>This item is included in the Quick Setup Wizard.</p> <p>➔ Quick Setup Wizard (Fax Setup) (page 2-7)</p>
ECM TX	<p>Set whether ECM TX is performed.</p> <p>ECM is a communication mode specified by the ITU-T (International Telecommunication Union) that retransmits data when an error occurs. Fax machines that have ECM mode check for errors as they communicate, preventing distortion of the image due to noise on the line and other conditions.</p> <p>Value: On, Off</p> <p> NOTE When there is a large amount of noise on the line, communication may take slightly longer than when [Off] is selected.</p>
TX Start Speed	<p>Set the TX Start Speed.</p> <p>When communication conditions are bad, the fax may not be transmitted correctly. In that case, set a lower TX Start Speed.</p> <p>Value: 9600bps, 14400bps, 33600bps</p> <p> NOTE Normally this should be used with the default setting.</p>
Cont Scan w/Platen	<p>Set the default settings for Continuous Scan, used when the original is placed on the platen for transmission.</p> <p>Value: Off, On</p> <p> NOTE: When [On] is selected, this setting is given priority over Continuous Scan (FAX) and Continuous Scan settings.</p> <p>➔ Continuous Scan (FAX) (page 8-6)</p> <p>➔ Continuous Scan (page 3-18)</p>

Reception

Item	Description
Media Type	<p>Specify the paper type to be used for print output of the received fax.</p> <p>Value: All Media Types, Plain, Rough, Vellum, Labels, Recycled, Bond, Cardstock, Color, Envelope, Thick, High Quality, Custom 1-8</p> <p>➔ Media Type for Print Output (page 4-7)</p>
Reception Date/Time	<p>Reception Date/Time function adds the reception date/time, sender information and number of pages on the top of each page when the message is printed out. It is useful for confirming the time of reception if the fax is from a different time zone.</p> <p>Value: Off, On</p> <p>➔ Reception Date/Time (page 4-6)</p>
Duplex Printing	<p>When received multiple pages of data are the same width, they can be printed out on both sides of paper having the same width as the data.</p> <p>Value: Off, On</p> <p>➔ Duplex Printing (page 4-6)</p>

Item	Description
2 in 1 Print	<p>When you receive a multi-page Statement or A5 size original, this function prints 2 pages of the original at a time on one Letter or A4 size sheet of paper.</p> <p>Value: Off, On</p> <p>➔ 2 in 1 Print (page 4-6)</p>
Batch Print	<p>When a multi-page fax is received, the pages are printed in a batch after all pages are received. If [Off] is set, each page is printed as it is received.</p> <p>Value: Off, On</p> <p>➔ Batch Print (page 4-6)</p>
Rings(Normal)	<p>If the reception method is fax automatic reception, the number of rings until the machine answers a call can be changed as needed.</p> <p>Value: 1 - 15</p>
Rings (Answering Machine)	<p>If the reception method is FAX/Answering Machine Auto Switch Reception, the number of rings until the machine answers a call can be changed as needed.</p> <p>Value: 1 - 15</p>
Rings(FAX/TEL)	<p>If the reception method is FAX/TEL Auto Switch Reception, the number of rings until the machine answers a call can be changed as needed.</p> <p>Value: 0 - 15</p> <p>For Rings (FAX/TEL), this change is possible with some countries.</p>
Reception Mode	<p>Select the reception mode.</p> <p>Value: Auto (Normal), Auto (FAX/TEL), Auto (Answering Machine), Manual, Auto (DRD)</p> <p>If Auto (DRD) is selected, select the DRD Pattern.</p> <p>Value: Pattern 1 (Normal Ring), Pattern 2 (Double Ring), Pattern 3 (Short-Short-Long), Pattern 4 (Short-Long-Short)</p> <p>DRD reception mode is available for some countries.</p> <p>➔ FAX Automatic Reception (page 4-2)</p> <p>Manual Reception (page 4-4)</p> <p>FAX/TEL Auto Switch Reception (page 5-28)</p> <p>FAX/Answering Machine Auto Switch Reception (page 5-30)</p> <p>DRD Reception (Available for some countries.) (page 5-32)</p>
Remote SW Dial	<p>To start fax reception by operation from the connected telephone set, use the following operation.</p> <p>Value: 00 - 99</p> <p>➔ Remote Switch Function (page 5-36)</p>
Encrypted Reception	<p>Turns on reception by encrypted communication.</p> <p>Value: Off, On</p> <p>If turned on, select the encryption key.</p> <p>➔ Encryption (page 5-23)</p>
ECM RX	<p>Set whether ECM RX is performed.</p> <p>ECM is a communication mode specified by the ITU-T (International Telecommunication Union) that retransmits data when an error occurs. Fax machines that have ECM mode check for errors as they communicate, preventing distortion of the image due to noise on the line and other conditions.</p> <p>Value: On, Off</p> <p> NOTE</p> <p>When there is a large amount of noise on the line, communication may take slightly longer than when [Off] is selected.</p>
RX Start Speed	<p>Change the RX Start Speed.</p> <p>When communication conditions are bad, the fax may not be received correctly. In that case, set a lower RX Start Speed.</p> <p>Value: 9600bps, 14400bps, 33600bps</p> <p> NOTE</p> <p>Normally this should be used with the default setting.</p>

TX/RX Restriction

This function allows you to send or receive originals only when communication requirements are met.

➔ [Transmission Restriction \(page 8-11\)](#)

Forward Settings

When you have received a fax, you can forward the received image to other faxes and computers or specify a number of copies.

➔ [Forward Settings \(page 5-2\)](#)

New Destination Entry(FAX)

Item	Description
New Destination Entry(FAX)	Select whether to permit direct entry of destination. When this option is set to [Prohibit] , you cannot enter the destination directly. <i>Value:</i> Permit, Prohibit

Transmission Restriction

This function allows you to send or receive originals only when communication requirements are met. Using this function can limit other parties with which you can communicate.

Specifically, you must register communication requirements (Permit FAX No./Permit ID No.) and set the transmission limit in advance. When the machine sends or receives originals, you do not need to perform a special operation for this particular function, and you can operate the machine normally. When sending or receiving has actually started, the machine correctly conducts transmission that meets communication requirements, but when the transmission does not meet the requirements, the machine indicates an error. This mode also allows you to set a **[Reject List]** for Reception Restriction so that reception from senders on the list of Rejected FAX numbers or from senders whose Local FAX Number is not registered are rejected. (You can select whether reception from a party whose local fax number is not registered is allowed or rejected in “Unknown Number Reception”.)

➔ [Unknown Number Reception \(page 8-18\)](#)



NOTE

Before using transmission restriction, be sure to read the following prerequisites, communication establishing requirements, and reception rejection requirements thoroughly, and consult with the other parties with which you communicate.

	Prerequisites	Communication Establishing Requirements
Send Restrictions	<ul style="list-style-type: none"> Register Permitted FAX numbers or Permitted ID numbers.* ➔ Registering Permit FAX No. (page 8-12) Registering Permit ID No. (page 8-16) Send restriction settings are specified in [Permit List + Address Book] in Send Restrictions. ➔ Setting Send Restriction (page 8-18) Register the Local FAX Numbers or Local FAX IDs of other parties. 	<ul style="list-style-type: none"> The recipient's Local FAX Number matches a Permitted FAX No. registered on the machine. The recipient's Local FAX ID matches a Permitted ID registered on the machine. When the number was dialed using the Address Book or One Touch Key, the last 4 digits of the dialed number match the last 4 digits of the recipient's Local FAX Number. (Excludes manual transmissions.)
Reception Restrictions	<ul style="list-style-type: none"> Register Permitted FAX numbers or Permitted ID numbers.** ➔ Registering Permit FAX No. (page 8-12) Registering Permit ID No. (page 8-16) Reception restriction settings are specified in [Permit List + Address Book] in Reception Restrictions. ➔ Setting Reception Restriction (page 8-18) Register the Local FAX Numbers or Local FAX IDs of other parties. 	<ul style="list-style-type: none"> The sender's Local FAX Number matches a Permitted FAX No. registered on the machine. The sender's Local FAX ID matches a Permitted ID registered on the machine. A fax number that matches the last 4 digits of the sender's Local FAX Number is registered in the Address Book on this machine.

* If there is neither a Permitted FAX No. nor a Permitted ID No. registered for the recipient, sending is not rejected.

** If there is neither a Permitted FAX No. nor a Permitted ID No. registered for the sender, reception is not rejected.

	Prerequisites	Reception Rejection Requirements
Reception Rejection	<ul style="list-style-type: none"> Register Reject FAX numbers.* ➔ Registering Reject FAX No. (page 8-14) Reception restriction settings are specified in [Reject List] in Reception Restrictions. ➔ Setting Reception Restriction (page 8-18) 	<ul style="list-style-type: none"> The sender's Local FAX Number is not registered. The sender's Local Fax Number matches a Reject FAX No. registered on the machine.

* If there are no Reject FAX numbers registered, calls are only rejected from senders whose Local FAX Numbers (Indicates local FAX information entries, not the actual line numbers.) are not registered.

Registering Permit FAX No.



NOTE

Up to 25 Permit FAX numbers can be registered.

1 Display the screen.

[System Menu/Counter] key > [FAX] > [TX/RX Restriction] > [Permit No. List]

2 Add a permit fax number.

1 Select [+].



2 Use the numeric keys to enter Permit FAX No. Up to 20 digits can be entered.



NOTE

Select [Pause] to insert a pause (-) between numbers.

Select [Space] to enter a space.

Use [<] or [>] to move the cursor.

Selecting [Backspace] deletes the character to the left of the cursor.

3 Select [OK].

3 To register another permit fax number, repeat Steps 2-1 to 2-3.

Changing and Deleting Permit FAX No.

1 Display the screen.

[System Menu/Counter] key > [FAX] > [TX/RX Restriction] > [Permit No. List]

2 Change/Delete.

Changing

- 1 Select [...] for Permit FAX No. you want to change, and enter the new number.



NOTE

For the procedure for entering a number, refer to the following:

➔ [Registering Permit FAX No. \(page 8-12\)](#)

2 [OK] > [Yes]

The registration is changed.

Deleting

- 1 Select Permit FAX No. you want to delete, and select [🗑️].



2 Select [Yes].

The registration is deleted.

Registering Reject FAX No.



NOTE

Up to 25 Reject FAX numbers can be registered.

1 Display the screen.

[System Menu/Counter] key > [FAX] > [TX/RX Restriction] > [Reject No. List]

2 Add a Reject FAX No.

1 Select [+].

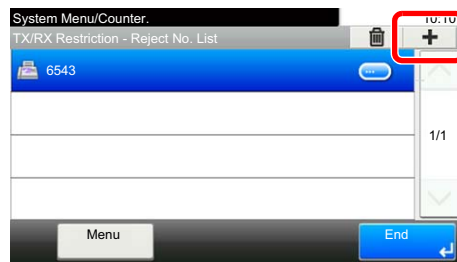

2 Use the numeric keys to enter Reject FAX No. Up to 20 digits can be entered.



NOTE

Select [**Pause**] to insert a pause (-) between numbers.

Select [**Space**] to enter a space.

Use [<] or [>] to move the cursor.

Selecting [**Backspace**] deletes the character to the left of the cursor.

3 Select [OK].

3 To register another Reject FAX No., repeat Steps 2-1 to 2-3.

Changing and Deleting Reject FAX No.

1 Display the screen.

[System Menu/Counter] key > [FAX] > [TX/RX Restriction] > [Reject No. List]

2 Change/Delete.

Changing

- 1 Select [...] for Reject FAX No. you want to change.

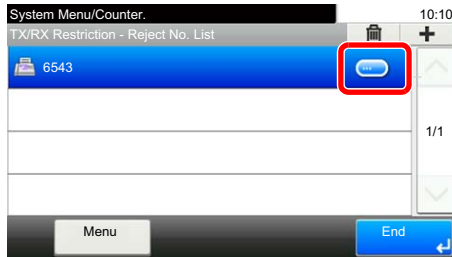

- 2 Enter the new number.



NOTE

For the procedure for entering a number, refer to the following:

➔ [Registering Reject FAX No. \(page 8-14\)](#)

- 3 [OK] > [Yes]

The registration is changed.

Deleting

- 1 Select Reject FAX No. you want to delete, and select [🗑️].

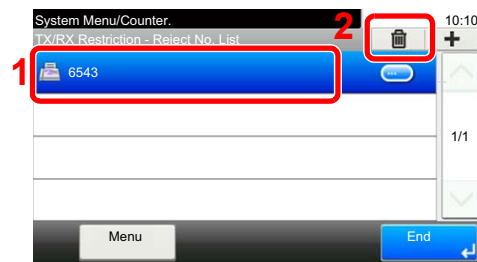

- 2 Select [Yes].

The registration is deleted.

Registering Permit ID No.



NOTE

Up to 10 Permit ID numbers can be registered.

1 Display the screen.

[System Menu/Counter] key > [FAX] > [TX/RX Restriction] > [Permit ID List]

2 Add a Permit ID No.

1 Select [+].

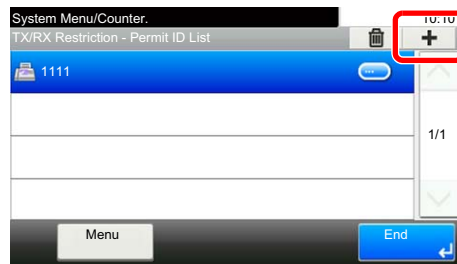

2 Use [+]/[-] or the numeric keys to enter Permit ID No. (0000 to 9999).

3 Select [OK].

3 To register another Permit ID No., repeat Steps 2-1 to 2-3.

Changing and Deleting Permit ID No.

1 Display the screen.

[System Menu/Counter] key > [FAX] > [TX/RX Restriction] > [Permit ID List]

2 Change/Delete.

Changing

- 1 Select [...] for Permit ID No. you want to change.

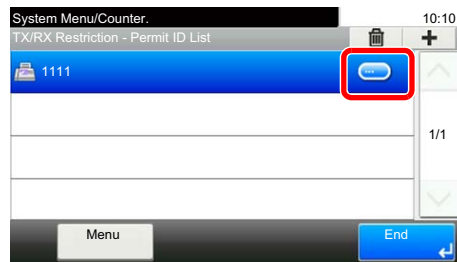

- 2 Enter the new number.



NOTE

For the procedure for entering a number, refer to the following:

➔ [Registering Permit ID No. \(page 8-16\)](#)

- 3 [OK] > [Yes]

The registration is changed.

Deleting

- 1 Select Permit ID No. you want to delete, and select [🗑️].

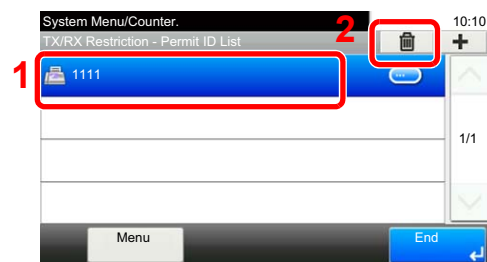

- 2 Select [Yes].

The registration is deleted.

Setting Send Restriction

Restrict the other parties to which you send originals only to the ones registered in Permit FAX No. and Permit ID No. as well as the ones registered in the Address Book. To change the sending restriction, follow the steps below.

1 Display the screen.

[System Menu/Counter] key > [FAX] > [TX/RX Restriction] > [TX Restriction]

2 Configure the function.

To not use the sending restriction, select [Off].

To restrict the other parties to which you send originals only to the ones registered in Permit FAX No. and Permit ID No. as well as the ones registered in the Address Book, select [**Permit List + Address Book**].

Setting Reception Restriction

Restrict incoming faxes so that you only receive originals from senders registered in Permit FAX No. and Permit ID No. and senders registered in your Address Book. This mode also allows you to set a [**Reject List**] for Reception Restriction so that reception from senders on the list of Rejected FAX numbers or from senders whose Local FAX Number is not registered are rejected. (You can select whether reception from a party whose local fax number is not registered is allowed or rejected in "Unknown Number Reception".)

➔ [Unknown Number Reception \(page 8-18\)](#)

To change the reception restriction, follow the steps below.

1 Display the screen.

[System Menu/Counter] key > [FAX] > [TX/RX Restriction] > [RX Restriction]

2 Configure the function.

To not use the reception restriction, select [Off].

To restrict the other parties from which you receive originals only to the ones registered in Permit FAX No. and Permit ID No. as well as the ones registered in the Address Book, select [**Permit List + Address Book**].

To block incoming faxes from senders registered in Reject FAX No., select [**Reject List**].

Unknown Number Reception

Select whether to receive the fax of that the number is unknown when [**Reject List**] is set for Reception Restriction.

To change the reception restriction for the unknown fax number, follow the steps below.

1 Display the screen.

[System Menu/Counter] key > [FAX] > [TX/RX Restriction] > [Unknown Number Reception]

2 Configure the function.

To receive faxes from the unknown number, select [**Permit**].

To reject faxes from the unknown number, select [**Reject**].

Unusable Time

This feature sets a time period during which the machine will not print received faxes.

IMPORTANT

When Unusable Time is set, in addition to fax printing, all other printing operations are prohibited during the unusable time period, including printing of copy jobs and printer jobs, and printing from USB memory.

Faxes and print jobs received during the unusable time period are printed after the unusable time period ends, or when the unusable time period is temporarily canceled.

NOTE

If the login user name entry screen appears during operations, log in by referring to the machine's *Operation Guide* for Administrator User Name and Password.

The factory default login user name and login password are set as shown below.

	P-4536i MFP	P-5536i MFP	P-6036i MFP
Login User Name:	4500	5500	6000
Login Password:	4500	5500	6000

1 Display the screen.

[System Menu/Counter] key > [Date/Timer/Energy Saver] > [Unusable Time]

2 Configure the function.

Set the unusable time

- 1 [On] > [Unusable Time]
- 2 Enter the start time.
- 3 Select [OK].
- 4 Enter the end time.

NOTE

If the same time is set as the start time and end time, you cannot use all day.

- 5 Select [OK].

Set the cancel code

Specify the code to temporarily cancel the unusable setting during unusable time.

- 1 Select [Unlock code].
- 2 Enter Unlock Code (0000 to 9999).
- 3 Select [OK].

NOTE

To use the machine temporarily during unusable time, enter the Unlock Code and select [Login].

Account Management

Account management is user management that specifies the users who can use the machine and job accounting that controls the usage per account. In user accounting, up to 100 users can be managed using User ID and Password. In job accounting, the status of fax use per account can be known for up to 100 accounts for sending of originals and making communication reservation after entering Account ID. For each management method, refer to the following:

➔ Machine's *Operation Guide*

It will be necessary to log in if user management or department management are enabled.
For the method for logging in, refer to the following:

➔ [Login/Logout \(page 3-13\)](#)

Description of User Accounting

Item	Description
Registration of User	Register user access privileges, User ID and Password.
Enable/Disable User accounting	Enable User accounting.



NOTE

➔ *Machine's Operation Guide*

Description of Job Accounting

Item	Description
Registration of Account	Register Account Name and Account ID. Up to 8 digits can be entered.
Enable/Disable job accounting	Enable job accounting.
FAX send restriction	Restricts the number of fax sheets that can be sent. You can prohibit the use of this sending function or cancel the sending restriction.
Counting of the number of used sheets	You can reset the counting, referring to the number of fax sheets to be sent and the time required for sending fax by all the accounts or by account.
Print of Accounting Report	You can print the printed and sent page numbers that have been counted by all the accounts.



NOTE

➔ *Machine's Operation Guide*

Communication modes subject to job accounting

- Normal transmission
- Delayed transmission
- Broadcast transmission
- Sub address transmission
- Encrypted transmission
- Manual send when dialed from this machine to the receiving system
- Polling reception
- Sending Faxes from PC

Restriction of use function

When you have enabled job accounting, you need to enter an Account ID when performing the following operations.

- Normal transmission
- Delayed transmission
- Broadcast transmission
- Sub address transmission
- Output from Sub address Box
- Encrypted transmission
- Manual send when dialed from this machine to the receiving system
- Polling reception
- Sending Faxes from PC

When job accounting has been enabled, batch transmission function works only for communication to be performed for the same Account ID. The communication to be performed with a different Account ID is not conducted as a batch transmission.

Normally, the Local FAX Name is printed in the transmit terminal identification (TTI). However, when Account Name Used is ON, the Account Name is printed.

9 Troubleshooting

This chapter explains the following topics:

Indicators During Sending/Receiving Operation	9-2
Responding to an Attention Indicator Flashes	9-2
Precautions When Turning Power OFF	9-3
Messages	9-4
Error Code List	9-5
Troubleshooting	9-8
Common inquiries	9-10

Indicators During Sending/Receiving Operation

The **[Processing]** and **[Memory]** indicators show the fax transmission status.

- The **[Processing]** indicator blinks during fax transmission and reception.
- The **[Memory]** indicator blinks when source data is being stored in memory for memory transmission.
- The **[Memory]** indicator is lit when there is source data stored in the memory for delayed transmission.



Responding to an Attention Indicator Flashes

If the **[Attention]** indicator flashes, select the **[Status/Job Cancel]** key to check an error message. If the message is not indicated on the touch panel when the **[Status/Job Cancel]** key is pressed or the attention indicator flashes for 1.5 seconds, check the following.

Symptom	Checkpoints	Corrective Actions	Reference Page
Cannot send fax.	Is the modular cord connected correctly?	Connect the modular cord correctly.	—
	Is Permitted FAX No. or Permitted ID No. registered correctly?	Check Permitted FAX No. and Permitted ID No.	8-11
	Has a communication error occurred?	Check error codes in the TX/RX Result Report and Activity Report. If the error code starts with "U" or "E", perform the corresponding procedure.	9-5
	Is the destination FAX line busy?	Send again.	—
	Does the destination FAX machine respond?	Send again.	—
	Is there an error other than above?	Contact your Service Representative.	—

Precautions When Turning Power OFF

To power off the machine, press the Power switch. You cannot automatically receive a fax when the power switch is turned off.

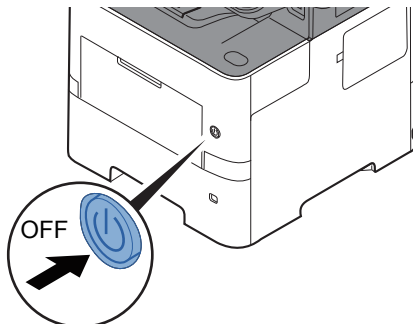

When [**Show Power Off Message**] is set, a shutdown confirmation screen is displayed.
It takes about 3 minutes for power off.

➔ [Show Power Off Message \(page 8-6\)](#)

Messages

When an error occurs, the display may show one of the messages listed below. These will help you identify and correct the problem.



NOTE

When a transmission error occurs, a sent/receipt result report is produced.

Check the error code shown in the report and refer to the following:

➔ [Error Code List \(page 9-5\)](#)

To print the sent/receipt result report, refer to the following:

➔ [Send Result Reports \(page 7-4\)](#)

[FAX RX Result Reports \(page 7-6\)](#)

You may also check error codes using the activity report.

➔ [Activity Report \(Outgoing FAX Report and Incoming FAX Report\) \(page 7-7\)](#)

Message	Checkpoint	Corrective Action	Reference Page
Add the following paper in cassette #.	Does the selected paper size match the paper size loaded in the specified paper source?	Select [Continue] to continue printing. Select [Cancel] to cancel the job.	—
	Is the indicated cassette out of paper?	Load paper. Select [Paper Selection] to select the other paper source. Select [Continue] to print on the paper in the currently selected paper source.	—
Box limit exceeded.	Is [End] displayed on the screen?	The specified box is full, and no further storage is available; Job is canceled. Select [End]. Try to perform the job again after printing or deleting data from the box.	—
Cannot process this job.	—	This job is canceled because it is restricted by User Authorization or Job Accounting. Select [End].	—
Job Accounting restriction exceeded.	Is the acceptable printing count restricted by Job Accounting exceeded?	The printing count exceeded the acceptable count restricted by Job Accounting. Cannot print any more. This job is canceled. Select [End].	Refer to the machine's Operation Guide .
Machine failure.	—	Internal error has occurred. Make a note of the error code displayed on the screen, and contact your Service Representative.	—
Scheduled sending jobs exceeded.	—	The number of jobs has exceeded the limit set for delayed transmission. Select [End]. The job is canceled. Wait until the delayed transmission is executed, or cancel the delayed transmission and then perform the job again.	3-20
The phone receiver is off the hook.	—	Put down the receiver.	—







Error Code List

When a transmission error occurs, one of the following error codes is recorded in the TX/RX Result Report and Activity Report.



NOTE

“U” or “E” will appear in the error code depending on the communication speed setting.

Error Code	Possible Cause/Action
Busy	Failed to establish connection with the recipient despite auto redialing the preset number of times. Send again.
CANCELED	Transmission was canceled due to an action to cancel transmission. Reception was canceled due to an action to cancel reception.
U00300	Paper depletion occurred at the recipient machine. Check with the recipient.
U00430 - U00462	Reception was canceled because of mismatching of communication features with the sender machine although the line connection was established.
U00601 - U00690	Communication was stopped due to the machine failure. Send or receive again.
U00700	Communication was stopped due to failure on the part of the sender or recipient machine.
U00800 - U00811	Page(s) not sent correctly. Send again. If you still have trouble, reduce TX Start Speed and send again.  NOTE If the communication error occurs frequently, change the default setting of TX Start Speed in System Menu.
U00900 - U00910	Page(s) not received correctly. Ask the sender to resend.  NOTE If the communication error occurs frequently, change the default setting of RX Start Speed in System Menu.
U01000 - U01097	Communication error occurred during transmission. Send again. If you still have trouble, reduce TX Start Speed and send again.  NOTE If the communication error occurs frequently, change the default setting of TX Start Speed in System Menu.
U01100 - U01196	Communication error occurred during reception. Ask the sender to resend.  NOTE If the communication error occurs frequently, change the default setting of RX Start Speed in System Menu.
U01400	Failed to establish communication with the sender or recipient machine because dialing registered for a tone line system was used in a pulse line system.
U01500	Communication error occurred during high-speed transmission. Send again. If you still have trouble, reduce TX Start Speed and send again.  NOTE If the communication error occurs frequently, change the default setting of TX Start Speed in System Menu.
U01600	Communication error occurred during reception of high-speed transmission. Ask the sender to reduce the transmission speed and send again.  NOTE If the communication error occurs frequently, change the default setting of RX Start Speed in System Menu.

Error Code	Possible Cause/Action
U01700 - U01720	<p>Communication error occurred during high-speed transmission. Send again. If you still have trouble, reduce TX Start Speed and send again.</p> <p> NOTE If the communication error occurs frequently, change the default setting of TX Start Speed in System Menu.</p>
U01721	<p>Communication error occurred during high-speed transmission. Designated transmission speed may not be available for the recipient machine. Reduce the transmission start speed and send again.</p>
U01800 - U01820	<p>Communication error occurred during reception of high-speed transmission. Ask the sender to reduce the transmission speed and send again or reduce the RX Start Speed in System Menu.</p>
U01821	<p>Communication error occurred during reception of high-speed transmission. Designated transmission speed may not be available for this machine. Ask the sender to reduce the transmission speed and send again or reduce the RX Start Speed in System Menu.</p>
U03000	<p>During polling reception, a fax could not be received because no originals were set in the other party's fax machine. Check with the other party.</p>
U03200	<p>Sub address bulletin board reception was attempted and the other party's machine is an our brand model, but the specified sub address box contained no data. Check with the other party.</p>
U03300	<p>An error occurred due to either 1 or 2 below. Check with the other party.</p> <ol style="list-style-type: none"> 1 The other party's machine is an our-brand model and transmission restrictions were found set by the other party during polling reception. Communication was interrupted because the password was incorrect. 2 The other party's machine is an our-brand model and transmission restrictions were found set by the other party during sub address bulletin board reception. Communication was interrupted because the password was incorrect.
U03400	<p>Polling reception was interrupted because the password entered by the other party did not match the Local FAX ID on the receiving machine. Check with the other party.</p>
U03500	<p>Sub address bulletin board reception was attempted and the other party's machine is an our brand model, but the specified sub address box was not registered on the other party's machine. Check with the recipient.</p>
U03600	<p>The other party's machine is an our-brand model and sub address bulletin board reception was interrupted because the specified sub address password was incorrect. Check with the other party.</p>
U03700	<p>Sub address bulletin board reception was attempted but the other party's machine either does not have a sub address bulletin board communication function or there were no originals in any of the originals transfer boxes (sub address boxes).</p>
U04000	<p>Specified sub address box is not registered in our brand recipient machine, or the sub address does not match.</p>
U04100	<p>Recipient machine is not equipped with a sub address box function, or the sub address does not match.</p>
U04200	<p>Encrypted transmission was canceled because the specified box is not registered.</p>
U04300	<p>Encrypted transmission was canceled because the recipient fax is not equipped with an encrypted communication function.</p>
U04400	<p>Encrypted transmission was canceled because the encryption key does not match.</p>
U04500	<p>Encrypted reception was canceled because the encryption key does not match.</p>
U05100	<p>Transmission was canceled because communication requirements are not met due to the transmission restriction set on this machine. Check with the recipient.</p>
U05200	<p>Reception was canceled because communication requirements are not met due to the reception restriction set on this machine.</p>

Error Code	Possible Cause/Action
U05300	Reception was rejected by the recipient because communication requirements are not met due to the reception restriction set on the recipient machine. Check with the recipient.
U14000	Reception to the Sub Address Box was stopped because there is no more free space in the memory of this machine. Create free space by outputting the data stored in the memory, or cancel the reception to the Sub Address Box.
U14100	Transmission to the Sub Address Box or sub address box on our-brand recipient machine was stopped because there is no more free space in the memory of the recipient machine. Check with the recipient.
U19000	Memory reception was stopped because there is no more free space in the memory of this machine. Create free space by outputting the data stored in the memory, and ask the sender to resend.
U19100	Transmission was stopped because there is no more free space in the memory of the recipient machine. Check with the recipient.
U19300	Transmission was stopped due to a data error occurring during transmission. Send again.

Troubleshooting

When a problem occurs, first check the following. If the problem persists, contact your dealer or service representative.

Symptom	Checkpoint	Corrective Action	Reference Page
Cannot send document.	Is the modular cord connected correctly?	Connect the modular cord correctly.	—
	Is <i>Send error</i> displayed?	Remedy the cause of error and send again.	9-5
	Is TX (transmission) restriction activated?	Cancel the TX restriction.	8-11
	Are you using an IP telephone line?	You may be able to temporarily clear the communication error by changing the setting of [TX Start Speed] in Transmission.	8-8
Cannot perform encrypted communication.	Are the registrations correct both at sender and recipient?	Double-check the registrations both at sender and recipient.	5-23
Cannot use the remote switching function.	Is a pulse line used?	Some phones may transmit tone signals using buttons. Refer to the operation manual of your phone set.	—
	Is the remote switching number correct?	Check the registration. (Default: 55)	8-9
No print output after reception.	Is memory forwarding activated?	Check the forwarding destination.	5-2
Cannot receive document.	Is the modular cord connected correctly?	Connect the modular cord correctly.	—
	Is <i>Communication error</i> displayed?	Remedy the cause of error and ask the sender to retry.	9-5
	Are you using an IP telephone line?	You may be able to temporarily clear the communication error by changing the setting of [RX Start Speed] in Reception.	8-9
	Is RX (reception) restriction activated?	Cancel the RX restriction.	8-11
Cannot perform memory reception.	Is free space available in the memory?	Receive after the memory has free space, or create free space in the memory.	—
Cannot perform sub address transmission.	Is the recipient fax machine equipped with a sub address transmission feature?	Sub address transmission cannot be performed unless the recipient fax machine has a similar sub address transmission feature.	—
	Is the entered sub address or sub address password identical to the sub address or sub address password registered in the recipient fax machine?	If your entry is correct, check with the recipient. This machine does not use a sub address password for reception.	5-14
	Is free space available in the memory of the recipient fax machine?	Check with the recipient.	—
Cannot perform memory forwarding.	Is memory forwarding set to [On] ?	Check the memory forwarding setting.	5-2

Symptom	Checkpoint	Corrective Action	Reference Page
Cannot perform memory forwarding using a sub address.	Is the recipient fax machine equipped with a sub address transmission feature?	Sub address transmission cannot be performed unless the recipient fax machine has a similar sub address transmission feature.	—
	Is the entered sub address identical to the sub address registered in the recipient fax machine?	If your entry is correct, check with the recipient. This machine does not use a sub address password for reception.	5-2
Cannot output from a Sub Address Box.	Is the box password been set?	Enter the correct box password.	5-8
Cannot use polling reception.	Is polling transmission being used correctly on the sending machine?	Check with the recipient.	—
Cannot use sub address bulletin board communication.	Does the other party's fax machine have the same sort of sub address bulletin board communication function?	If the other party's fax machine does not have the same sort of sub address bulletin board communication function, it cannot receive faxes via a sub address bulletin board. Check with the recipient.	—
	Is the entered sub address or sub address password correct?	If your entry is correct, check with the recipient.	—

Common inquiries

The following are the inquiries that are frequently received after this product has been purchased.

	Question	Answer
1	I want to add a completion stamp when sending faxes.	This product does not have a function for completion stamps.
2	I want to send and receive faxes in color.	Fax images are transmitted and received in black and white.

10 Appendix

This chapter explains the following topics:

- Character Entry Method 10-2
- Specifications 10-5
- Menu Map 10-7
- Received FAX Sizes and Paper Priority (Metric Model) 10-13
- Received FAX Sizes and Paper Priority (Inch Model) 10-14

Character Entry Method

To enter characters for a name, use the on-display keyboard in the touch panel following the steps as explained below.

NOTE

QWERTY, QWERTZ and AZERTY are keyboard layouts the same as a PC keyboard are available. If necessary, change the layout. For information on how to change layouts, refer to the following:

▶ *Machine's Operation Guide*

QWERTY layout is used here as an example. You may use another layout following the same steps.

Entry Screens

Lower-case Letter Entry Screen

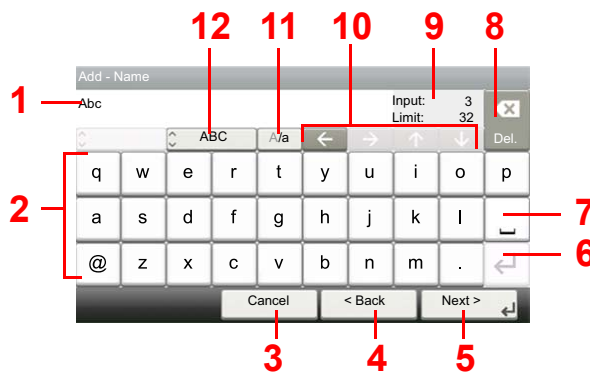

No.	Display/Key	Description
1	Display	Displays entered characters.
2	Keyboard	Select the character to enter.
3	[Cancel]	Select to cancel entered characters and return to the screen before the entry was made.
4	[< Back]	Select to return to the previous screen.
5	[OK] / [Next >]	Select to save the entered characters and move to the next screen.
6	Enter Key	Select to enter a line break.
7	Space Key	Select to insert a space.
8	Delete Key	Select to delete a character to the left of the cursor.
9	[Input] / [Limit] Display	Displays maximum number of characters and the number of characters entered.
10	Cursor Key	Select to move the cursor on the display.
11	[A/a] / [a/A]	Select to switch between upper case and lower case.
12	[ABC] / [Symbol]	Select the characters that are entered. To enter symbols or numbers, select [Symbol].

Upper-case Letter Entry Screen



Number/Symbol Entry Screen

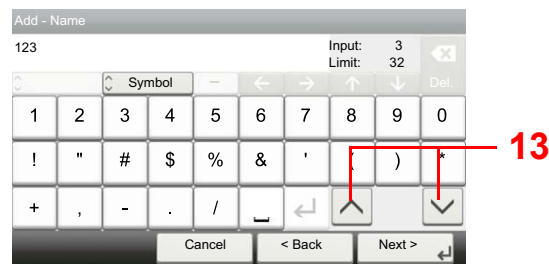

No.	Display/Key	Description
13	[▲]/[▼]	To enter a number or symbol not shown in the keyboard, select the cursor key and scroll the screen to view other numbers or symbols to enter.

Entering Characters

Follow the steps below to enter 'List A-1' for an example.

1 Enter 'List', (space).

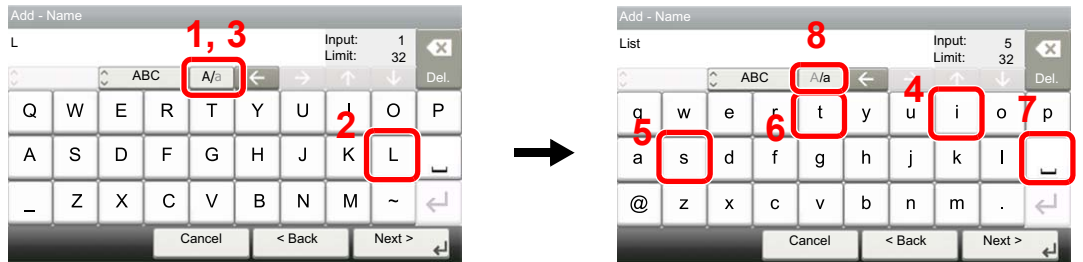

To shift from lower case to upper case letters, select [a/A]. To shift from upper case to lower case letters, select [A/a].

2 Enter 'A-1'.

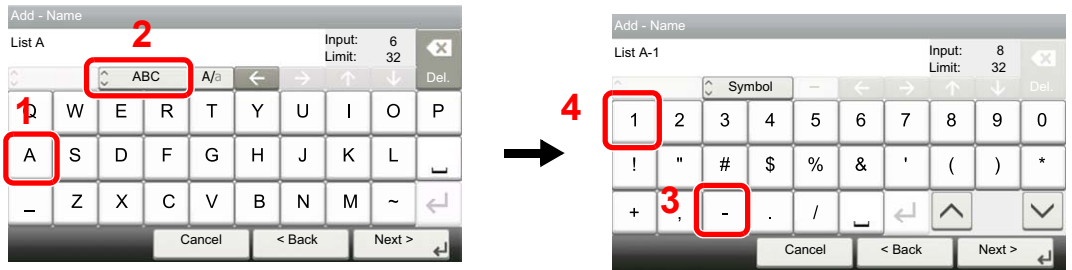

To enter numbers or symbols, select [ABC] to display [Symbol].

3 Register the characters you entered.

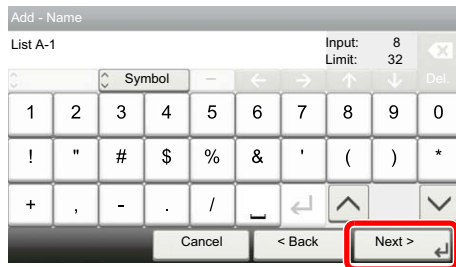

Select [Next>]. The entered characters are registered.

Specifications

IMPORTANT

Specifications are subject to change without notice.

FAX function

Item	Description
Compatibility	G3
Communication Line	Subscriber telephone line
Transmission Time	Less than 3 seconds (33600 bps, JBIG, ITU-T A4-R #1 chart)
Transmission Speed	33600/31200/28800/26400/24000/21600/19200/16800/14400/12000/9600/7200/4800/2400 bps
Coding Scheme	JBIG/MMR/MR/MH
Error Correction	ECM
Original Size	Max. width: 8.51"/216 mm, Max. length: 36.03"/915 mm
Automatic Document Feed	P-4536i MFP: Max. 75 sheets (with document processor) P-5536i MFP/P-6036i MFP: Max. 100 sheets (with document processor)
Resolution	Scan: 200 × 100 dpi Normal (8 dot/mm × 3.85 line/mm) 200 × 200 dpi Fine (8 dot/mm × 7.7 line/mm) 200 × 400 dpi Super (Super Fine) (8 dot/mm × 15.4 line/mm) 400 × 400 dpi Ultra (Ultra Fine) (16 dot/mm × 15.4 line/mm) Print: 600 × 600 dpi
Gradations	256 shades (Error diffusion)
One Touch Key	100 keys
Multi-Station Transmission	Max. 100 destinations
Substitute Memory Reception	256 sheets or more (when using ITU-T A4 #1)
Image Memory Capacity	3.5 MB (standard)(For fax transmission and reception)
Report Output	Send result report, FAX RX result report, Activity report, Status page

Network FAX functions

Item	Description
Hardware	IBM PC-AT compatible computer
Interface	10BASE-T, 100BASE-TX, 1000BASE-T
Operating system	Windows Server 2008/2012/2016 and Windows 7/8/8.1/10
Transmission Resolution	Ultra fine (400 × 400dpi), Fine (200 × 200dpi), Normal (100 × 200dpi)
Document Size	Letter, Legal, Statement, A4, A5, Folio, B5(JIS)
FAX Delayed Transmit	Based on settings in the Network FAX Driver (setting is possible to any 1 minute increment within the subsequent 24 hour period)
Transmit and Print	Fax transmission and print out at the machine is available
Broadcast Transmission	Up to 100 destinations
Job Accounting	Requires the input of a Login User Name and Password in the Network FAX Driver when User Login, is turn ON in the fax machine. Requires the input of an Account ID in the Network FAX Driver when Job Accounting, is turned ON in the fax machine.
Cover Page	A format can be selected using the Network FAX Driver or a template can be created.

Menu Map



Add Dest. (page 3-7)	
Address Book (page 3-9)	
Ext. Address Book (refer to <i>Embedded Web Server RX User Guide</i>)	
One Touch Key (page 3-10)	
Functions	Quiet Mode (page 3-16)
	Original Size (page 3-16)
	Original Orientation (page 3-16)
	Duplex (page 3-16)
	FAX TX Resolution (page 3-17)
	Density (page 3-17)
	Original Image (page 3-17)
	Continuous Scan (page 3-18)
	File Name Entry (page 3-23)
	Long Original (page 3-23)
	Job Finish Notice (page 3-23)
	FAX Delayed Transmission (page 3-20)
	FAX Direct Transmission (page 3-18)
	FAX Polling RX (page 5-17)
	FAX TX Report (page 3-23)
Add/Edit Shortcut (refer to the machine's <i>Operation Guide</i>)	



Sub Address Box (page 5-8)



Polling Box (page 5-15)
--



FAX Memory RX Box (page 5-21)
--

Status/
Job Cancel



Print Job Status (refer to the machine's <i>Operation Guide</i>)
Send Job Status (refer to the machine's <i>Operation Guide</i>)
Store Job Status (refer to the machine's <i>Operation Guide</i>)
Scheduled Job (page 3-21)
Print Job Log (refer to the machine's <i>Operation Guide</i>)

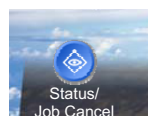

Send Job Log (refer to the machine's <i>Operation Guide</i>)	
Store Job Log (refer to the machine's <i>Operation Guide</i>)	
FAX Job Log	Outgoing FAX Log (page 7-3)
	Incoming FAX Log (page 7-3)
	Outgoing FAX Report (page 7-7)
	Incoming FAX Report (page 7-7)
Scanner (refer to the machine's <i>Operation Guide</i>)	
Printer (refer to the machine's <i>Operation Guide</i>)	
FAX Memory RX Box (refer to the machine's <i>Operation Guide</i>)	
FAX	Line Off (page 3-5)
	Manual RX (page 4-4)
Toner Status (refer to the machine's <i>Operation Guide</i>)	
Paper Status (refer to the machine's <i>Operation Guide</i>)	
Removable Memory (refer to the machine's <i>Operation Guide</i>)	
USB Keyboard (refer to the machine's <i>Operation Guide</i>)	
Bluetooth Keyboard (refer to the machine's <i>Operation Guide</i>)	
Network Connection Status (refer to the machine's <i>Operation Guide</i>)	
Option Network Connection Status (refer to the machine's <i>Operation Guide</i>)	
Wi-Fi Direct (refer to the machine's <i>Operation Guide</i>)	
Wireless Network (refer to the machine's <i>Operation Guide</i>)	
Wi-Fi (refer to the machine's <i>Operation Guide</i>)	
SSD (refer to the machine's <i>Operation Guide</i>)	

System Menu / Counter

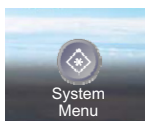

Quick Setup Wizard	FAX Setup (page 2-7)
	Paper Setup (refer to the machine's <i>Operation Guide</i>)
	Energy Saver Setup (refer to the machine's <i>Operation Guide</i>)
	Network Setup (refer to the machine's <i>Operation Guide</i>)
Language (refer to the machine's <i>Operation Guide</i>)	

Report (page 8-4)	Report Print (page 8-4)	Status Page (page 7-8)	
		Font List (refer to the machine's <i>Operation Guide</i>)	
		Network Status (refer to the machine's <i>Operation Guide</i>)	
		Service Status (refer to the machine's <i>Operation Guide</i>)	
		Accounting Report (refer to the machine's <i>Operation Guide</i>)	
		Sub Address Box List (page 5-13)	
		FAX List (Index) (page 2-16)	
		FAX List (No.) (page 2-16)	
		Outgoing FAX Report (page 7-7)	
		Incoming FAX Report (page 7-7)	
		Optional Network Status (refer to the machine's <i>Operation Guide</i>)	
		Data Sanitization Report (refer to the machine's <i>Operation Guide</i>)	
	Admin Report Settings (page 7-7)	Outgoing FAX Report (page 7-7)	
		Incoming FAX Report (page 7-7)	
	Result Report Setting	Send Result Report	E-mail/Folder (refer to the machine's <i>Operation Guide</i>)
FAX (page 7-4)			
Attach Image of Network FAX (page 7-4)			
Canceled before Sending (page 7-5)			
Recipient Format (page 7-5)			
RX Result Report		FAX (page 7-6)	
		RX Result Report Type (page 7-9)	
Job Finish Notice Setting (refer to the machine's <i>Operation Guide</i>)			
Send Log History (refer to the machine's <i>Operation Guide</i>)			
Counter (refer to the machine's <i>Operation Guide</i>)			
User Property (refer to the machine's <i>Operation Guide</i>)			
Cassette/MP Tray Settings	Cassette 1 (to 5) (page 8-5)		
	Multi Purpose Tray (page 8-5)		



















Common Settings	Default Screen (refer to the machine's <i>Operation Guide</i>)	
	Sound (page 8-5)	Buzzer (refer to the machine's <i>Operation Guide</i>)
		FAX Speaker Volume (page 8-5)
		FAX Monitor Volume (page 8-5)
	Original Settings (refer to the machine's <i>Operation Guide</i>)	
	Paper Settings (refer to the machine's <i>Operation Guide</i>)	
	Function Defaults	FAX TX Resolution (page 8-6)
		Continuous Scan (FAX) (page 8-6)
	Preset Limit (refer to the machine's <i>Operation Guide</i>)	
	Error Handling (refer to the machine's <i>Operation Guide</i>)	
	Color Toner Empty Action (refer to the machine's <i>Operation Guide</i>)	
	Measurement (refer to the machine's <i>Operation Guide</i>)	
	Low Toner Alert (refer to the machine's <i>Operation Guide</i>)	
	Display Status/Log	Display FAX Log (page 8-6)
	Remote Printing (refer to the machine's <i>Operation Guide</i>)	
	Function Key Assignment (page 8-6)	
	Show Power Off Message (page 8-6)	
Message Banner Print (refer to the machine's <i>Operation Guide</i>)		
Home (refer to the machine's <i>Operation Guide</i>)		
Copy (refer to the machine's <i>Operation Guide</i>)		
Send (refer to the machine's <i>Operation Guide</i>)		
Document Box	Custom Box (refer to the machine's <i>Operation Guide</i>)	
	Sub Address Box (page 5-8)	
	Job Box (refer to the machine's <i>Operation Guide</i>)	
	Polling Box (page 5-15)	
	FAX Memory RX Box (page 5-21)	

FAX (page 8-7)	TX/RX Common (page 8-7)	Encryption Key Registration (page 5-23)
		FAX Remote Diagnosis (page 8-7)
	Transmission (page 8-7)	Local FAX Name (page 8-7)
		Local FAX ID (page 8-7)
		Local FAX Number (page 8-7)
		TTI (page 8-7)
		Account Name Use (page 8-7)
		Dialing Mode(Inch version only) (page 8-7)
		Retry Times (page 8-7)
		ECM TX (page 8-7)
		TX Start Speed (page 8-7)
		Cont Scan w/Platen (page 8-7)
	Reception (page 8-8)	Media Type (page 8-8)
		Reception Date/Time (page 8-8)
		Duplex Printing (page 8-8)
		2 in 1 Print (page 8-8)
		Batch Print (page 8-8)
		Rings(Normal) (page 8-8)
		Rings (Answering Machine) (page 8-8)
		Rings(FAX/TEL) (page 8-8)
Reception Mode (page 8-8)		
Remote SW Dial (page 8-8)		
Encrypted Reception (page 5-23)		
ECM RX (page 8-8)		
RX Start Speed (page 8-8)		
TX/RX Restriction (page 8-11)		
Forward Settings (page 5-2)		
New Destination Entry(FAX) (page 8-10)		
Application (refer to the machine's <i>Operation Guide</i>)		
Internet (refer to the machine's <i>Operation Guide</i>)		
Address Book/One Touch	Address Book (page 3-9)	
	One Touch Key (page 3-10)	
	Address Book Defaults	Sort (refer to the machine's <i>Operation Guide</i>)
		Address Book (refer to the machine's <i>Operation Guide</i>)
	Edit Restriction (refer to the machine's <i>Operation Guide</i>)	
Print List (page 2-16)		
User Login/Job Accounting (refer to the machine's <i>Operation Guide</i>)		
Printer (refer to the machine's <i>Operation Guide</i>)		

System/Network (refer to the machine's <i>Operation Guide</i>)	
Date/Timer/Energy Saver	Date/Time (page 2-9)
	Date Format (refer to the machine's <i>Operation Guide</i>)
	Time Zone (page 2-9)
	Auto Panel Reset (refer to the machine's <i>Operation Guide</i>)
	Panel Reset Timer (refer to the machine's <i>Operation Guide</i>)
	Low Power Timer (refer to the machine's <i>Operation Guide</i>)
	Sleep Level (Except for Europe) (refer to the machine's <i>Operation Guide</i>)
	Sleep Rules (Europe only)
	Sleep Timer (refer to the machine's <i>Operation Guide</i>)
	Energy Saver Recovery Level (refer to the machine's <i>Operation Guide</i>)
	Weekly Timer Settings (refer to the machine's <i>Operation Guide</i>)
	Auto Error Clear (refer to the machine's <i>Operation Guide</i>)
	Error Clear Timer (refer to the machine's <i>Operation Guide</i>)
	Unusable Time (page 8-19)
Ping Timeout (refer to the machine's <i>Operation Guide</i>)	
Adjustment/Maintenance (refer to the machine's <i>Operation Guide</i>)	

Received FAX Sizes and Paper Priority (Metric Model)

When no paper loaded in the cassettes matches the received fax size and orientation, the machine automatically chooses the printing paper according to the following priority.

		Received FAX Size				
Priority		A5	A4	Folio	A4 Long Originals*	Folio Long Originals**
						
Paper Size	1	A5*** 	A4 	Folio 	A4 	Folio 
	2	A4 	Folio 	A4 		A4**** 
	3	Folio 	B5****,***** 	A4 		A4 
	4	B5*** 				

* A4 Long Originals: Originals longer than A4 in the direction of the paper feed.

** Folio Long Originals: Originals longer than Folio in the direction of the paper feed.

*** Paper orientation is different from the received document. The image is printed after being rotated 90° automatically.

**** Images longer than Folio length (330 mm) are received and printed on A4 paper without dividing them.

***** Images shorter than the A4 vertical length (297 mm) are received and then reduced and printed on B5 paper (horizontal width 182 mm).

 : indicates print output on two sheets.

NOTE

















When a paper type is selected in *Media Type*, a received fax is printed using the matching paper source.

➔ [Media Type for Print Output \(page 4-7\)](#)

If **[All Media Types]** is selected, a paper type cannot be specified for fax printouts.

Received FAX Sizes and Paper Priority (Inch Model)

When no paper loaded in the cassettes matches the received fax size and orientation, the machine automatically chooses the printing paper according to the following priority.

		Received FAX Size				
Priority		Statement 	Letter 	Legal 	Letter Long Originals* 	Legal Long Originals** 
Paper Size	1	Statement*** 	Letter 	Legal 	Letter 	Legal 
	2	Letter 	Legal 	Letter 		Letter**** 
	3	Legal 		Letter 		Letter 

* Letter Long Originals: Originals longer than Letter in the direction of the paper feed.

** Legal Long Originals: Originals longer than Legal in the direction of the paper feed.

*** Paper orientation is different from the received document. The image is printed after being rotated 90° automatically.

**** Images longer than the Legal length (14 inches) are received and printed on Letter paper without dividing them.

 : indicates print output on two sheets.

NOTE

When a paper type is selected in *Media Type*, a received fax is printed using the matching paper source.

➔ [Media Type for Print Output \(page 4-7\)](#)

If [**All Media Types**] is selected, a paper type cannot be specified for fax printouts.

Index

Numerics

2 in 1 Print 4-6, 8-9

A

Account Management 8-20
Account Name Use 8-7
Address Book 2-11, 3-9
 Adding a contact 2-11
 Adding a Group 2-13
 Change/Deletion 2-14
 Printing Address List 2-16
 Search 3-9
 Select a Destination 3-9

B

Batch Print 4-6, 8-9
Batch Transmission Function 3-20
Broadcast Transmission 3-11

C

Cancel
 Cancelling Delayed Transmission 3-21
 Cancelling Direct Transmission 3-18
 Cancelling Memory Transmission 3-5
 Cancelling Polling Transmissions 5-16
 Cancelling Transmission (Disconnection of
 Communication) 3-5
Cannot perform sub address transmission 9-8
Cannot receive document 9-8
Cannot send document 9-8
Chain Dial 3-24
Character Entry Method 10-2
Checking Transmission Results
and Registration Status 7-2
Common inquiries 9-10
Confirmation Screen of Destinations 7-10
Continuous Scan 3-18

D

Date 2-9
Default fax settings 8-2
Delayed Transmission
 Immediate Transmission 3-21
Density 3-17
Direct Transmission
 Cancel 3-18
Document Processor 2-3
DRD Reception 5-32
Duplex 3-16
Duplex Printing 4-6, 8-8

E

ECM RX 8-9
ECM TX 8-8
E-mail Notice
 Job Finish Notice 3-23
 Reporting FAX Receipt Result 7-9
Encryption Communication 5-23
 Changing and Deleting Registration Contents of
 Encryption Key 5-25
 Encryption Box No. 5-23
 Encryption Key 5-24
 Encryption Key No. 5-23
 Registering an Encryption Key 5-24
 Setting the Encrypted Reception 5-27
 Using the Encrypted Transmission 5-26
Encryption RX 8-9
Enter key 2-6
Error Code List 9-5

F

FAX/Answering Machine Auto Switch Reception 5-30
FAX/TEL Auto Switch Reception 5-28
FAX Automatic Reception 4-2, 8-9
FAX Delayed Transmission 3-20
 Immediate Transmission 3-21
FAX Direct Transmission 3-18
 Cancel 3-18
FAX Driver
 Basic Transmission 6-7
 Flow of Receiving 6-2
 Flow of Sending 6-2
 Installing the FAX Driver 6-3
 Setup 6-3
FAX Job History 7-3
 Job Log Screen 7-3
FAX Media Type 4-7
FAX Memory RX Box 5-21
 Deleting a fax received in FAX Memory RX Box 5-22
 Printing a fax received in FAX Memory RX Box 5-21
FAX TX Report 3-23
FAX TX Resolution 3-17
File Name Entry 3-23
Forward Settings 5-2
 Embedded Web Server RX 5-7
 Type of Forwarding Destination 5-2
Function Key Assignment 8-6

H

Home Screen 2-5

I

Indicators 9-2
Interrupt Send 3-22

J

- Job Accounting 8-20
 - Communication Form Subject to Job Accounting 8-20
 - Contents 8-20
 - Limit 8-21
 - Login 3-14

L

- Local FAX ID 2-7, 8-7
- Local FAX Name 2-7, 8-7
- Local FAX Number 2-7, 8-7
- Long Original 3-23

M

- Machine (Names) 2-2
- Manual Reception 4-4, 5-35
- Manual Send 3-19, 5-34
- Media Type for Print Output 4-7, 8-8
- Memory Reception 4-3
- Memory Transmission 3-2
 - Cancel 3-5
- Menu Map 10-7
- Messages 9-4

N

- Network FAX
 - Basic Transmission 6-7
 - Flow of Receiving 6-2
 - Flow of Sending 6-2
 - Installing the FAX Driver 6-3
 - Setup 6-3
- No Print Output 9-8

O

- One Touch Key 2-17
 - Adding a Destination 2-17
 - Change/Delete 2-18
 - Select Destination 3-10
- Operation Panel 2-4
- Original Image 3-17
- Original Orientation 3-16
- Original Size 3-16

P

- Part Names and Functions 2-2
- PBX Setting 2-10
- Permit Fax No.
 - Change/Deletion 8-13
 - Registration 8-12
- Permit ID No.
 - Change/Deletion 8-17
 - Registration 8-16
- Polling Communication 5-15
 - Checking 5-20
 - Deleting Originals in a Polling Box 5-20
 - Polling Reception 5-17
 - Polling Transmission 5-15
 - Printing from a Polling Box 5-19
 - Sub Address Bulletin Board Reception 5-17
- Precautions When Turning Power OFF 9-3
- Priority Override Send 3-4

Q

- Quick No. Search key 2-6
- Quick Setup Wizard 2-7
- Quiet Mode 3-16

R

- Received FAX Sizes and Paper Priority 10-13, 10-14
- Receiving Mode 4-2, 8-9
- Reception Date/Time 4-6, 8-8
- Redial 3-6
 - Changing Retry Times 8-8
- Reject Fax No.
 - Change/Deletion 8-15
 - Registration 8-14
- Remote Switch Function 5-36, 8-9
 - How to Register 8-9
 - How to Use 5-36
- Report
 - Activity Report 7-7
 - FAX RX Result Reports 7-6
 - Printing a Sub Address Box List 5-13
 - Recipient Format 7-9
 - Report for Job Canceled before Sending 7-5
 - Send Result Reports 7-4
 - Sub Address Box List 5-13
- Rings
 - Answering Machine 8-9
 - FAX/TEL 8-9
 - Normal 8-9
- RX Date/Time 4-6
- RX Start Speed 8-9

S

- Selection of Transmit Terminal Identification (TTI) 2-7,

8-7
Send Status 3-4
Sound
 FAX Monitor Volume 8-5
 FAX Speaker Volume 8-5
 Job Finish 8-5
Sound Volume
 FAX Monitor Volume 2-7
 FAX Speaker Volume 2-7
 Job Finish Buzzer 2-7
Specifications 10-5
Speed Dial key
 Select Destination 3-10
Standby Transmission 3-21
Sub Address Box Function 5-8
 Checking 5-12
 Deleting Originals after Printing from a Sub Address
 Box 5-12
 Deleting Originals from a Sub Address Box 5-13
 How to Change 5-10
 How to Delete 5-10
 How to Register 5-9
 Printing Originals from Sub Address Box 5-11
 Sub Address Box List 5-13
Sub Address Bulletin Board Reception 5-17
Sub Address Communication 5-8
 Sub Address 5-8
 Sub Address Password 5-8
 Sub Address Transmission 5-14

T

Telephone Line 2-7, 8-8
Time 2-9
Touch Panel 2-5
Transmission Restriction 8-11
 Communication Establishing Requirements 8-11
 Permit FAX No. 8-12
 Permit ID No. 8-16
 Prerequisites 8-11
 Reception Rejection Requirements 8-12
 Reception Restriction Setting 8-18
 Reject FAX No. 8-14
 Send Restriction Setting 8-18
 Unknown Number Reception 8-18
Troubleshooting 9-8
TX Start Speed 8-8

U

Unusable Time 8-19
User Accounting 8-20
 Contents 8-20
 Login 3-13
Using favorites 3-26

**QUALITY
CERTIFICATE**

This machine has passed
all quality controls and
final inspection

